

# METHANOL AS MARINE FUEL: ENVIRONMENTAL BENEFITS, TECHNOLOGY READINESS, AND ECONOMIC FEASIBILITY

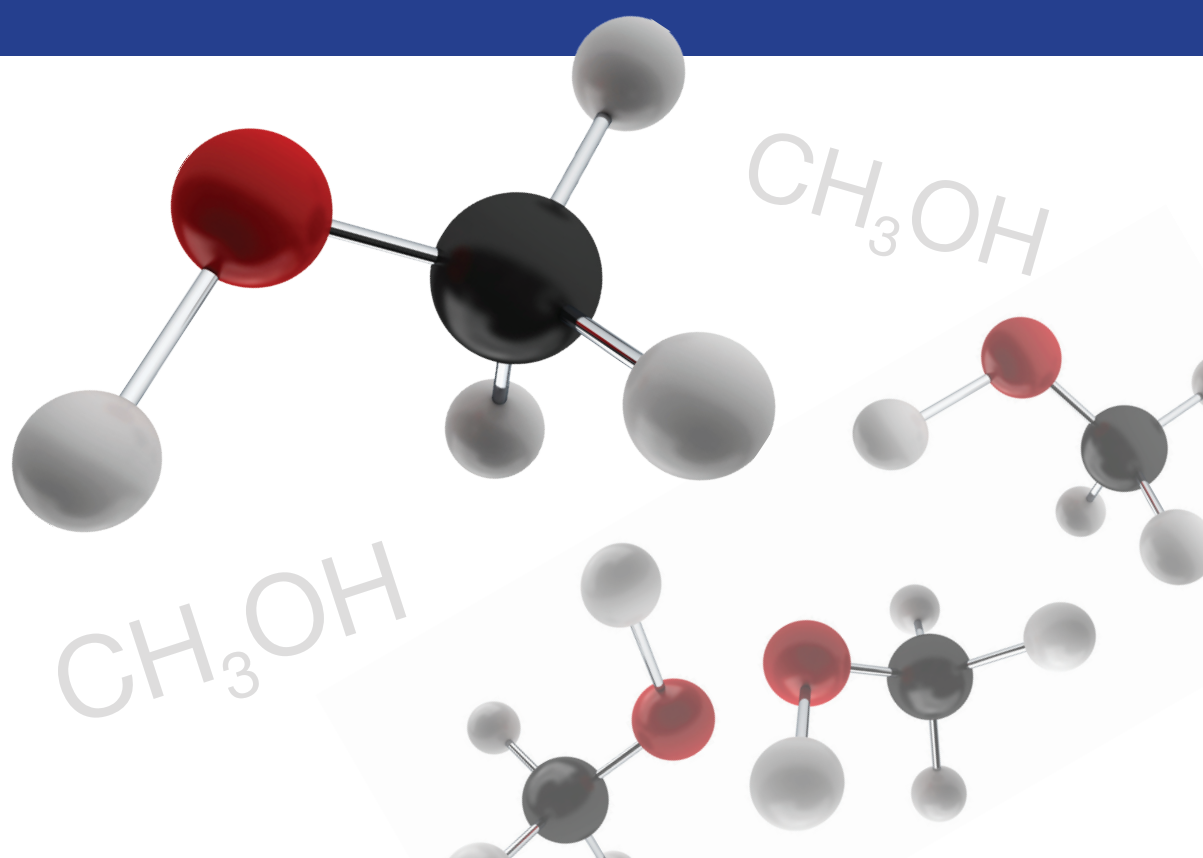



# **Methanol as marine fuel: Environmental benefits, technology readiness, and economic feasibility**

*Published in 2016 by the*  
INTERNATIONAL MARITIME ORGANIZATION  
4 Albert Embankment, London SE1 7SR  
www.imo.org

Printed by Micropress Printers, Suffolk, UK

Copyright © International Maritime Organization 2016

*All rights reserved.  
No part of this publication may be reproduced,  
stored in a retrieval system, or transmitted in any form or by any means,  
without prior permission in writing from the  
International Maritime Organization.*

*This study was carried out and published using funds provided to IMO by Transport Canada  
for analytical studies and other activities pertaining to the control of  
air related emissions from ships.*

*The views and conclusions drawn in this report are those of the authors of the report.*

This publication has been prepared from official documents of IMO, and every effort  
has been made to eliminate errors and reproduce the original text(s) faithfully.

# Contents

Page

- Abbreviations ..... v
- 1 Executive summary** ..... 1
- 2 Introduction** ..... 3
  - 2.1 Methanol in industry ..... 3
- 3 The current environmental regulatory regime** ..... 5
  - 3.1 IMO regulations ..... 5
  - 3.2 Other regional requirements ..... 8
- 4 Identifying the environmental benefits of methanol** ..... 9
  - 4.1 Methanol fuel production ..... 10
    - 4.1.1 Methanol production with natural gas ..... 10
    - 4.1.2 Methanol production with biomass ..... 12
  - 4.2 Combustion of methanol on board ships ..... 13
  - 4.3 Lifecycle emissions of conventional fuels ..... 14
  - 4.4 Comparing lifecycle emissions of methanol to conventional fuels ..... 16
    - 4.4.1 Greenhouse gas emissions ..... 16
    - 4.4.2 Lifecycle NO<sub>x</sub> and SO<sub>x</sub> emissions ..... 17
- 5 Identification of technology readiness** ..... 19
  - 5.1 Introduction ..... 19
  - 5.2 System breakdown ..... 19
    - 5.2.1 Bunkering of methanol ..... 20
    - 5.2.2 Storage of methanol on board ..... 21
    - 5.2.3 Handling and processing of methanol towards the main engine ..... 23
    - 5.2.4 Combustion of methanol in the main engine ..... 25
    - 5.2.5 Methanol handling and processing after the main engine ..... 27
    - 5.2.6 Ship type considerations ..... 28
  - 5.3 Summary of technology readiness ..... 30
  - 5.4 Costs of methanol as fuel ..... 32
    - 5.4.1 Methanol price from the shipowner’s perspective –  
Payback time for methanol propulsion ..... 32
    - 5.4.2 Methanol price based on methanol production ..... 36
  - 5.5 Encouraging the use of methanol ..... 37
- 6 Conclusions** ..... 39
- 7 References** ..... 41



# Abbreviations

|                 |   |
|-----------------|---|
| ECA             | Emission Control Area                         |
| FMECA           | Failure mode, effect and criticality analysis |
| GHG             | Greenhouse Gas                                |
| HAZID           | Hazard identification                         |
| HFO             | Heavy fuel oil                                |
| IMO             | International Maritime Organization           |
| IR              | Infra-Red                                     |
| MGO             | Marine gas oil                                |
| NO <sub>x</sub> | Nitrogen oxides                               |
| SECA            | Sulphur Emission Control Area                 |
| SO <sub>x</sub> | Sulphur oxides                                |



# 1

## Executive summary

The purpose of the study is to determine the environmental benefits of using methanol as fuel on ships with regards to emissions of greenhouse gases (GHGs), NO<sub>x</sub> and SO<sub>x</sub>. The potential environmental gains are seen in the context of current and future environmental regulations for methanol in maritime use, and in context of the costs of adaption and technical readiness.

The environmental assessment of methanol used as ship fuel shows that, for a lifecycle perspective, methanol produced with natural gas has higher GHG emissions than conventional fuels. However, methanol produced with biomass has the potential to save significant emissions, provided that the electricity used in the process is relatively clean. The lifecycle NO<sub>x</sub> emissions from methanol are approximately 45% of those from conventional fuels per unit energy and the lifecycle SO<sub>x</sub> emissions of methanol are approximately 8% of those from conventional fuels per unit energy. In the case of both NO<sub>x</sub> and SO<sub>x</sub>, the emissions reductions are due to the fact that methanol results in lower emissions during the combustion phase.

The assessment of technology readiness for methanol as fuel shows that the methanol fuel system consists mostly of well-known components, and that the individual components are of a mature technology and have been used in the maritime industry. The new application is the connection of all these components along the methanol flow and how they interact with each other. The assessment also shows that additional safety barriers are needed in every part of the methanol fuel system. From a technical aspect this is very much achievable for shipowners, both for newbuild and retrofit systems.

From a cost perspective, methanol as fuel only shows potential within certain circumstances. These are mainly that MGO prices are high and that the time spent in ECAs for the vessel is a large portion of the total sailing time.





# 2

## Introduction

This study was carried out using funds provided to IMO by Transport Canada for analytical studies and other activities pertaining to the control of air related emissions from ships.

The purpose of the study is to determine the environmental benefits of using methanol as fuel on ships with regards to emissions of greenhouse gases (GHGs), NO<sub>x</sub> and SO<sub>x</sub>. The potential environmental gains will be seen in the context of current and future environmental regulations for methanol in maritime use, and in context of costs of adaption and technical readiness.

Methanol has been given attention as a low carbon alternative fuel because it can be synthesized from a number of feedstocks. Beyond the possibility of producing methanol with renewable resources, methanol is an environmentally interesting fuel for ships due to its low sulphur, NO<sub>x</sub> and particulate emissions. The low sulphur emissions make methanol an alternative for satisfying the IMO sulphur emission control area (SECA) requirements for SO<sub>x</sub>.

The Swedish ferry and freight operator Stena Line has successfully retrofitted one of its vessels for using methanol as a solution to low sulphur fuel requirements. This is the world's first and only vessel running on methanol, at the time of writing. Additionally, a number of chemical carriers are also being designed to be able to run on methanol, so that they can use their own methanol cargo as fuel in SECAs.

This analysis will address the question: what are the environmental benefits of methanol and what makes a shipowner choose methanol over other traditional and alternative fuels?

### 2.1 Methanol in industry

Methanol, also known as methyl alcohol or wood alcohol, is a chemical with the formula CH<sub>3</sub>OH. Most methanol produced today is used in the petrochemical industry, employing methanol as a feedstock to produce other chemicals, in particular formaldehyde and acetic acid<sup>1/</sup>.

Today methanol is generally produced using natural gas as a feedstock. Methanol has piqued interest as an alternative, low-carbon fuel because it is also possible to produce with renewable feedstocks such as municipal waste, industrial waste, biomass and carbon dioxide<sup>2/</sup>.

Methanol is only employed as a transportation fuel on a significant basis for cars in China, where it is inexpensive and readily available. Methanol in China is produced cheaply from coal, which causes a highly negative GHG impact.

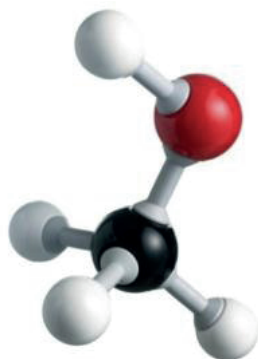

**Figure 2-1:** Symbolic representation of methanol molecule, CH<sub>3</sub>OH

The use of methanol in the maritime industry is currently limited. As mentioned previously, Stena Line has retrofitted a ro-ro passenger vessel for methanol use. There are currently seven chemical tankers under construction which will ship methanol and run on their cargo.

# 3

## The current environmental regulatory regime

The current regulations in place which can work to encourage the uptake of methanol for shipowners are related to restrictions on sulphur oxide (SO<sub>x</sub>), the most important being SO<sub>x</sub> restrictions imposed by IMO in emission control areas (ECAs) and in EU by the Sulphur Directive 1999/32/EC (as amended by Directive 2012/33/EU).

### 3.1 IMO regulations

The main international shipping convention regulating emissions to air from ships is the IMO *International Convention on the Prevention of Pollution from Ships* (referred to as MARPOL). MARPOL Annex VI establishes limits for SO<sub>x</sub> and NO<sub>x</sub> globally and in ECAs.

The global limit of sulphur content in fuel will be reduced from 3.5% to 0.5% (m/m) in 2020 or 2025. The date of implementation will be decided by 2018. The use of scrubbers will be accepted in this regime.

Ships sailing in SO<sub>x</sub> ECAs (SECAs) are required to run on fuel with a sulphur content of 0.1% (m/m) or less after January 2015, alternatively using an equivalent method such as exhaust gas cleaning, or alternative fuels with low sulphur content. There are two established SECAs: the Northern European SECA, and the North American and US Caribbean ECA. These are shown in Figure 3-1.

There is a possibility for new ECAs in Mexico and Turkey (the Bosphorus Straits and Sea of Marmara).

Equivalent purification of exhaust gas from HFO by scrubbers is accepted (except in California where it is banned by state regulation, but this ban is expected to be lifted in 2015).

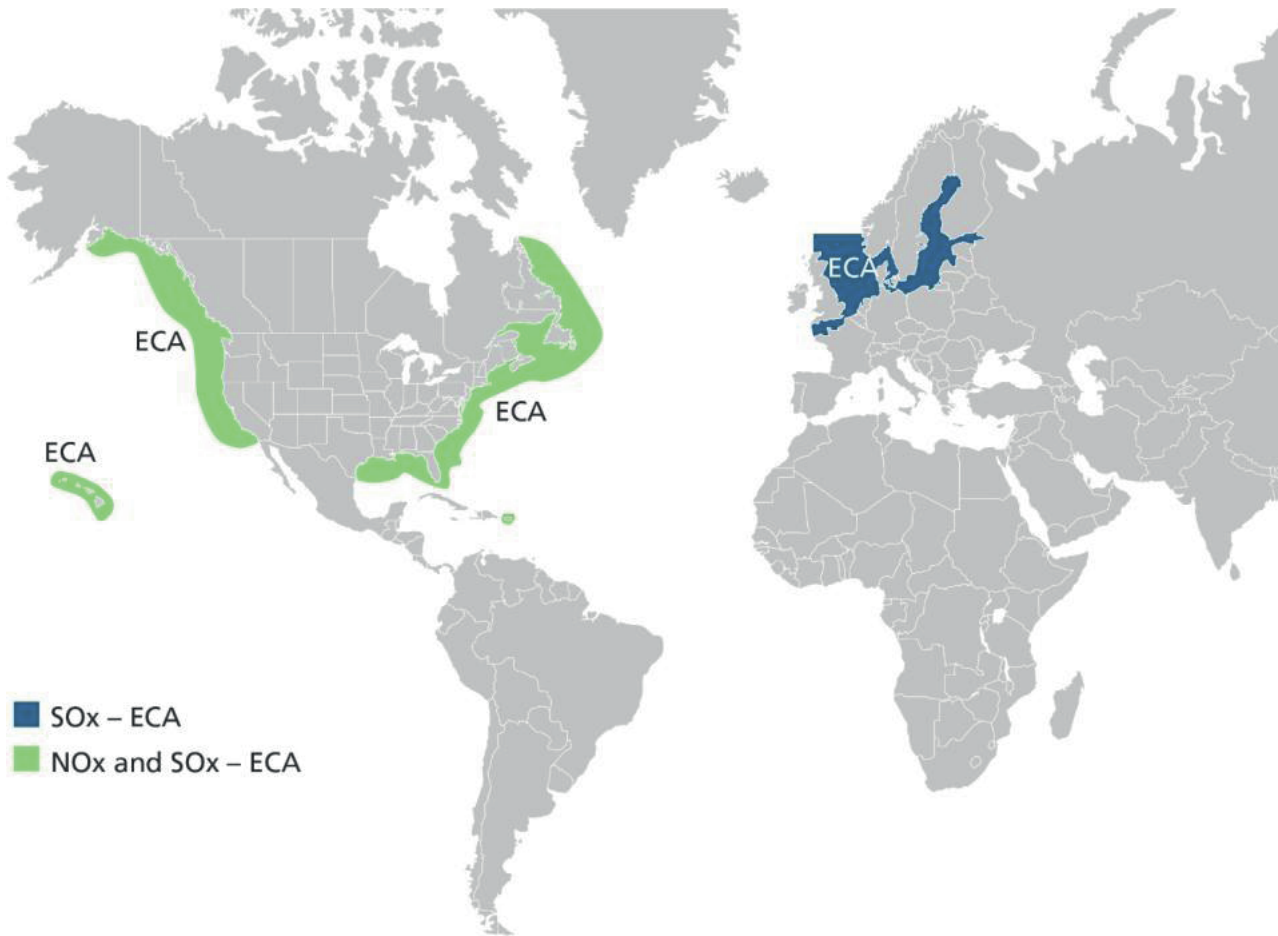

**Figure 3-1:** Current established emission control areas

MARPOL Annex VI also establishes limits for  $\text{NO}_x$  emissions from marine diesel engines of more than 130 kW output, dependent on engine mean rotational speed and the ship construction date (keel-laid date of the ship). The keel-laid date determines if a vessel is beholden to Tier I, II or III:

Tier I – Ships keel laid from 1 January 2000 to 1 January 2011

Tier II – Ships keel laid on or after 1 January 2011

Tier III – Ships keel laid after 1 January 2016 operating in the North American Emission Control Area or the United States Caribbean Sea Emission Control Area.

The relevant  $\text{NO}_x$  emissions for each tier level are shown in Figure 3-2.

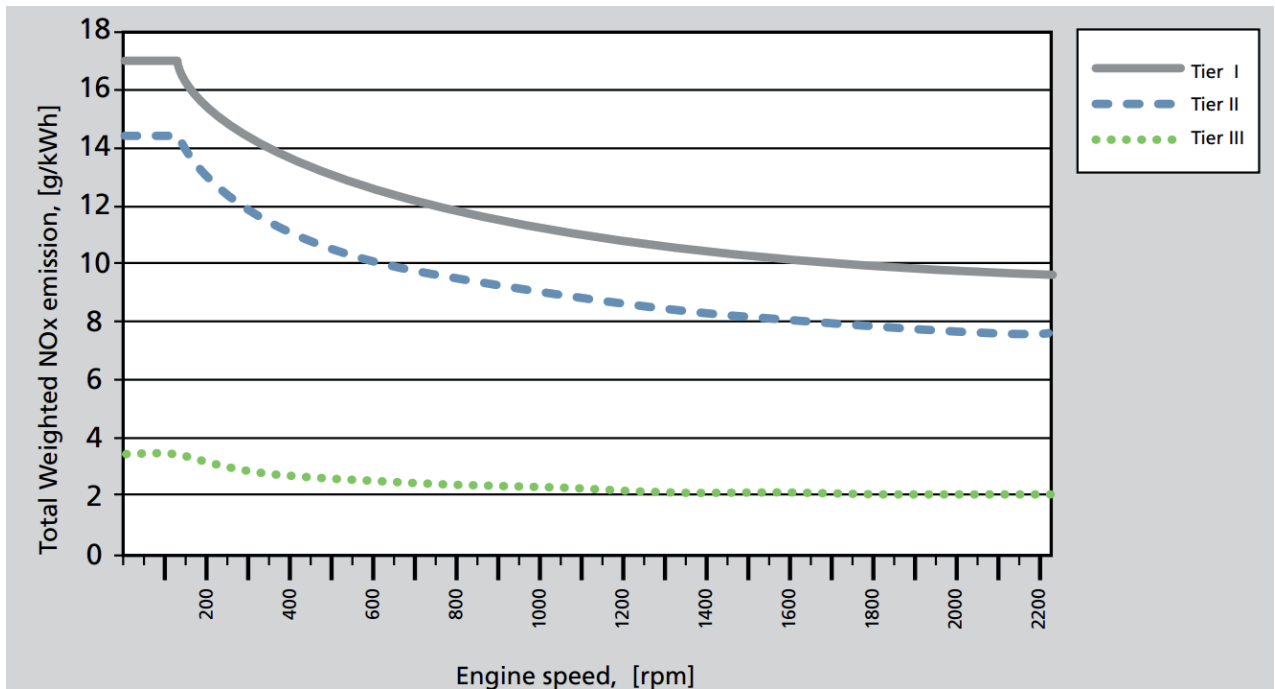

**Figure 3-2:** Allowable NO<sub>x</sub> emissions from marine engines according to tier

Currently, the only established NO<sub>x</sub> ECAs (NECA) are the North American ECA and the United States Caribbean Sea ECA.

The keel-laid date after which vessels must adhere to Tier III in future NECA's which can come into effect, cannot be earlier than the date of adoption of the NECA.

Beyond requirements for SO<sub>x</sub> and NO<sub>x</sub> pollution prevention, MARPOL Annex VI mandates the energy efficiency design index (EEDI) for new ships, as well as a Ship Energy Efficiency Management Plan (SEEMP) for all ships.

The EEDI establishes a mileage standard for ships where the environmental burden of running the ship (CO<sub>2</sub> emissions) is measured against the benefit for society (transport work).

$$\text{Attained design CO}_2 \text{ index} = \frac{\text{environmental burden}}{\text{benefit for society}}$$

The design EEDI has been established for selected ship types and sizes above 400 GT. Ships will be required to satisfy the required EEDI value which is valid for the ship type, size and keel date. The design EEDIs are intended to establish energy efficiency standards to which ships must adhere at the design stage. The later the keel-lay date, the more stringent the standard mandated by IMO. The EEDI requirements are in force but will evolve as part of an agreed review process.

Biofuels (such as methanol produced from biomass) are not considered in the existing EEDI regulation. The EEDI calculation guidelines<sup>3/</sup> establish a carbon factor for methanol, regardless of whether or not it is produced by biomass. However, the flag State may allow alternative fuel oils, or compliance methods used as an alternative to the requirements of the EEDI, if the alternative is at least effective in terms of emissions reductions as that required by the EEDI<sup>4/</sup>. This means that a flag State can allow for biofuels such as methanol created with biomass to satisfy the EEDI requirements as an alternative to energy efficiency requirements stipulated in the EEDI. Possibly there is a need to consider setting a different carbon factor for biofuels.

In such a case, vessels running on biofuels must document that their motor is built to run on biofuels and that biofuels are the primary fuel. Exactly how this is to be documented is not yet established, so it will be up to the flag State to determine which criteria will constitute a motor built and running on biofuels as the primary fuel and therefore to what extent bio-methanol will be advantageous in achieving compliance with EEDI, compared to other fuels.

### **3.2 Other regional requirements**

Other than the MARPOL requirements, EU's Sulphur Directive limits sulphur content in fuel to 0.5% in EU waters (non-ECA) beginning January 2020. Equivalent purification of exhaust gas from HFO by scrubbers is accepted, though scrubber discharge water is not accepted in certain coastal waters, ports and river estuaries.

Article 4b of the Council Directive 1999/32/EC as amended by Directive 2005/33/EC stipulates that ships at berth in European Union ports must use marine fuels with a maximum sulphur content of 0.1% (m/m) at all times.

The Directive also requires that all ships at berth in EU ports after 2010 must use marine fuels with a maximum sulphur content of 0.1% (m/m). The Directive also mandates that all passenger vessels on scheduled routes must burn fuel at equal or less than 1.5% in all EU waters. (Except in SECAs where stricter restrictions apply.)

There are currently no EU directives specifically targeting NO<sub>x</sub> emissions from ships.

ECA-like requirements are also likely forthcoming in parts of Chinese waters<sup>5/</sup>. The Chinese Ministry of Transport has indicated that it will establish emission control areas from 1 January 2016 in the Pearl River Delta, Yangtze River Delta and Bohai Rim. Vessels at berth inside the areas will be strongly advised to use bunker fuels with a sulphur content of less than 0.5% m/m sulphur.

# 4

## Identifying the environmental benefits of methanol

In order to identify the environmental benefits of using methanol as marine fuel, the total lifecycle emissions of methanol propulsion on ships are compared to conventional fuels – MGO and HFO. The lifecycle emissions of SO<sub>x</sub>, NO<sub>x</sub> and greenhouse gases (GHGs: CO<sub>2</sub>, CH<sub>4</sub> and N<sub>2</sub>O) are identified for the production and emission phases of methanol production.

The system boundaries for the lifecycle emissions are well-to-propeller, meaning that the emissions of extracting and refining raw fossil fuels are taken into account. The entire lifecycle can be divided into two main phases: well-to-tank (the total emissions of extracting raw materials, producing and transporting the fuel) and tank-to-propeller (the emissions from combustion and potential leakage).

The emissions of CO<sub>2</sub> and SO<sub>x</sub> from the combustion phase are dependent on the carbon and sulphur content of the fuel in question. The emissions of CH<sub>4</sub>, N<sub>2</sub>O and NO<sub>x</sub> are based on temperature and combustion conditions. These values will also vary with engine load and rpm, but average emissions factors in g/MJ fuel are used in this study.

All lifecycle emissions are normalized per MJ content of fuel.

Emissions of CH<sub>4</sub> and N<sub>2</sub>O have different contributions to global warming. These emissions are therefore normalized to g CO<sub>2</sub> equivalents, so that the total GHG emissions can be summed and the lifecycle GHG emissions from each fuel type can be compared. The CH<sub>4</sub> and N<sub>2</sub>O emissions are converted to CO<sub>2</sub> equivalents using a 100-year time horizon. This means that the CH<sub>4</sub> and N<sub>2</sub>O emissions are normalized according to their effect on global warming of a 100-year time scale. Normalization factors are given in Table 4-1.

**Table 4-1:** Global warming potential of CH<sub>4</sub> and N<sub>2</sub>O<sup>6/</sup>

| Emissions        | Global warming potential for 100-year time horizon (g CO <sub>2</sub> equivalents/g emissions) <sup>1</sup> |
|------------------|---|
| CO <sub>2</sub>  | 1   |
| CH <sub>4</sub>  | 25  |
| N <sub>2</sub> O | 298   |

CH<sub>4</sub> and N<sub>2</sub>O are not emitted in large quantities from combustion methanol or conventional marine fuels, but they are taken into account because they are emitted in the production process and their inclusion is important for the completeness of any lifecycle GHG inventory.

SO<sub>x</sub> and NO<sub>x</sub> emissions are important in a maritime context primarily because of their harmful effects on human health, land based infrastructure and natural habitats. Their emissions near ports or where humans are present is where they do most damage, but on a regional level they also contribute to acid rain creation and potentially local acidification of the marine environment. Their lifecycle emissions are therefore quantified here.

Particulate emissions are important from a human health perspective, with black-carbon also seeking attention as a short-lived climate change forcer and a potential ice-melt accelerant. However, such emissions are outside the scope of this study.

Additionally, methanol combustion does emit formaldehyde, which has a human health effect, but this is outside the scope of this study. Other issues outside the scope include the possible cooling effects of SO<sub>x</sub> and aerosols in the atmosphere, the formaldehyde emissions from methanol and the uncertainty of NO<sub>x</sub>'s impact on climate chemistry.

<sup>1</sup> The IPCC has made an update to global warming potential for CH<sub>4</sub> and N<sub>2</sub>O but values from the 2007 IPCC report are used here to ease comparison with other lifecycle assessments of marine fuels.



## 4.1 Methanol fuel production

### 4.1.1 Methanol production with natural gas

Currently, the methanol used on board the *Stena Germanica* – the only current vessel employing methanol in the world – is produced by natural gas synthesis, as is most of the methanol produced in the world today. The methanol Stena purchases can theoretically come from any number of production sites, with various natural gas sources as the feedstock. It is assumed here that the majority of methanol used by Stena is produced in Europe with natural gas produced from Norwegian fields.

Methanol production from natural gas entails a combination of steam reforming and partial oxidation, with up to about 70% energy efficiency<sup>77</sup>. The main emissions occurring during the production process are the emissions from combustion of natural gas. The process of producing methanol is highly exothermic, and the excess heat is used to generate electricity in a plant<sup>81</sup>. It can therefore be assumed that there are no extra energy inputs to the production process at the plant and that only negligible emissions occur beyond the natural gas combustion.

Further up the value chain, emissions will also occur from the extraction and transport of natural gas so that it can be used in the methanol plant. The emission estimates from natural gas extraction used in this study are based on natural gas extraction from Norwegian fields, and include emissions from transporting the gas to mainland Europe. Additionally, it is assumed that the emissions from transporting and bunkering methanol are the same as those for MGO and HFO. The difference in energy density of methanol is assumed to have a negligible impact on emissions from transport, which are small compared to other parts of the lifecycle.

The lifecycle of methanol production with natural gas is shown in Figure 4-1.

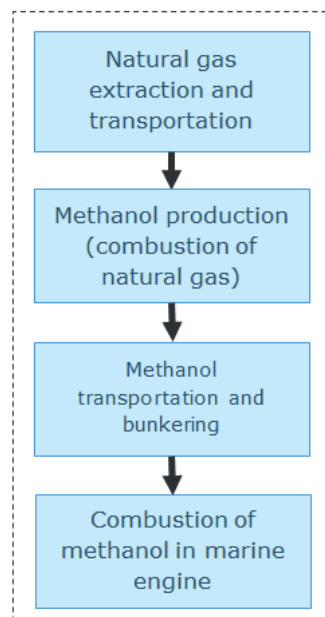
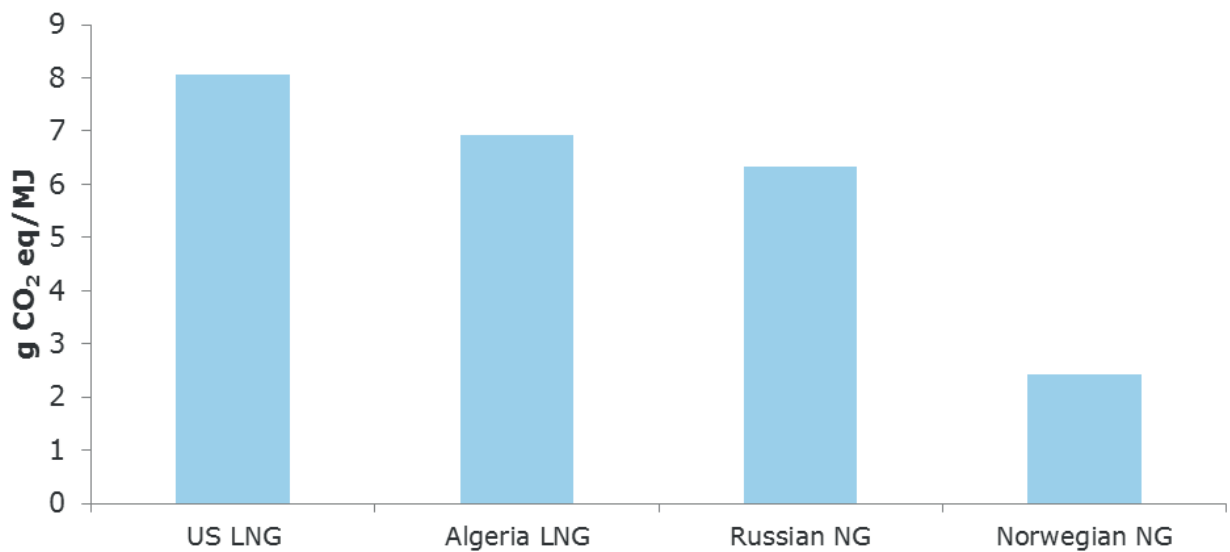

**Figure 4-1:** Map of lifecycle phases of methanol production and use as fuel in ships

The emissions from extracting the natural gas and transporting it to the methanol production site are based on the European Lifecycle Database (ELCD)<sup>97</sup>. These values are based on Norwegian natural gas extraction, and gas being sent via pipeline to a production site, totalling at 2.4 g CO<sub>2</sub> eq/MJ natural gas.

Different fields will have different energy requirements for extracting gas, and different efficiencies for gas processing and transportation.

Although it is difficult to compare different lifecycle assessment (LCA) studies because the system boundaries can vary, Figure 4-2 shows the GHG emissions from gas extraction in various locations, in order to show the variation in emissions from natural gas extraction<sup>100</sup>. The results are from a study performed by the US Department of Energy, with three scenarios: LNG produced in the US and shipped to Rotterdam, LNG produced in Algeria and shipped to Rotterdam, and natural gas produced in Russia and sent via pipeline to Rotterdam. The results of the three scenarios are shown with the emissions values of Norwegian natural gas production taken from the ELCD database.



**Figure 4-2:** GHG emissions of natural gas extraction

Figure 4-2 shows the emissions from extraction only. LNG will have additional emissions from liquefaction and other processing. Several studies choose to use emissions of Norwegian natural gas extraction to calculate the lifecycle values of fuel production when production occurs in Europe (Strømman et al. 2006<sup>11/</sup>; Brynolf et al. 2014<sup>12/</sup>).

Despite the uncertainty in the emissions of gas extraction and transportation, the well-to-tank GHG emissions from methanol produced with natural gas are dominated by the emissions from natural gas combustion occurring at the methanol plant. The well-to-tank emissions of methanol production with natural gas are shown in Figure 4-3.

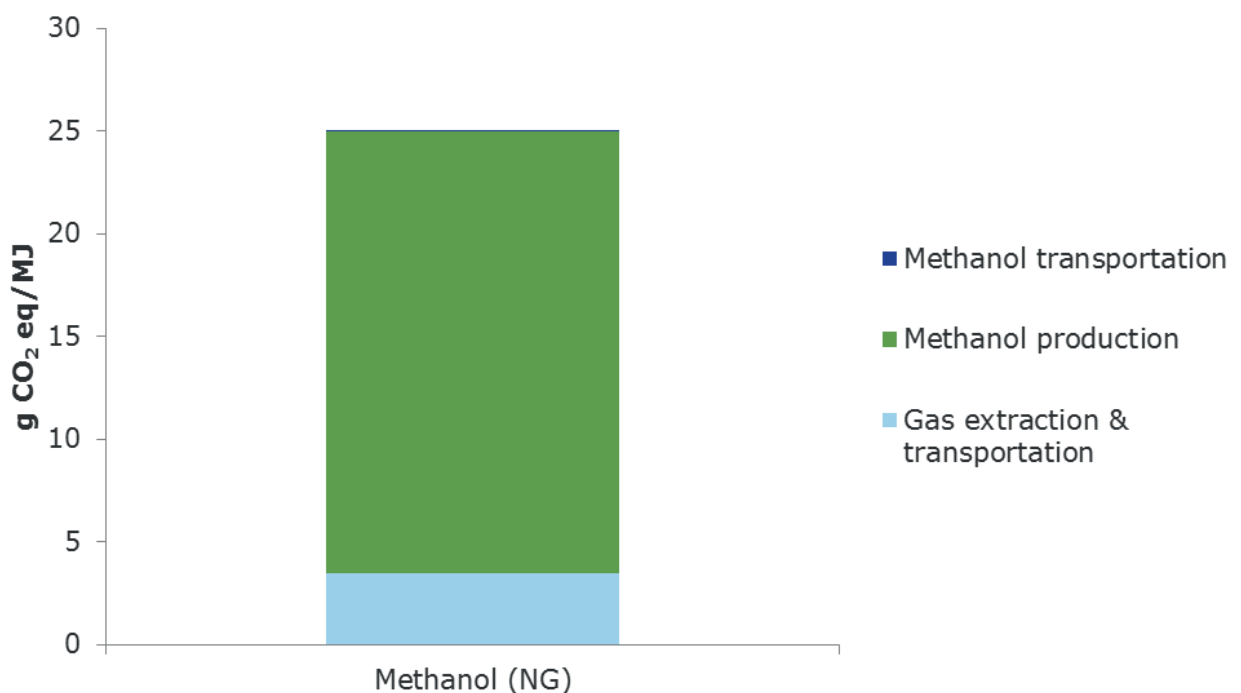

**Figure 4-3:** Well-to-tank GHG emissions from methanol produced with natural gas

The impact of methanol transportation is so small as to be barely visible in the figure.

### 4.1.2 Methanol production with biomass

Although today's limited application of methanol as fuel for ships is mostly synthesized from natural gas, it is important to consider the lifecycle emissions from methanol produced with biomass. It is the eventual transition to bio-methanol that is the environmental motivation for using methanol on ships as additional reason for sustainability beyond no sulphur content. Methanol can be produced with biomass such as residues from forestry. Biomass materials are used to make black liquor in pulp and paper mills, where it is normally combusted to generate energy and recover chemicals. However, black liquor can also be gasified in an oxygen-rich atmosphere and methanol produced from the resulting syngas, without compromising the recovery of the chemicals. This process may be integrated into the pulp and paper mill process with access to excess biomass<sup>13/</sup>. Such a methanol production process is the grounds for the lifecycle GHG estimates of bio-methanol below.

In such a process, the emissions from methanol production will come from the emissions generated elsewhere to create electricity needed. The source of electricity is an important factor for the total GHG emissions of methanol created with biomass, because the emissions from electricity generation can vary according to the raw energy source. The amount of renewable resources used to generate electricity varies from country to country. Figure 4-4 illustrates the upstream CO<sub>2</sub> emissions of the electricity mixes for various countries.

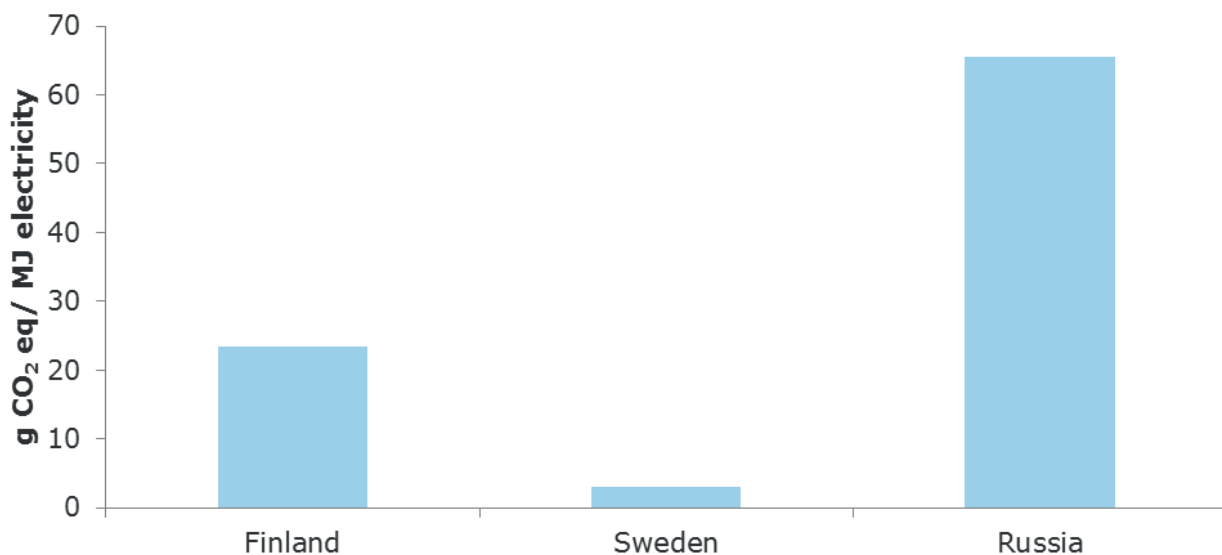
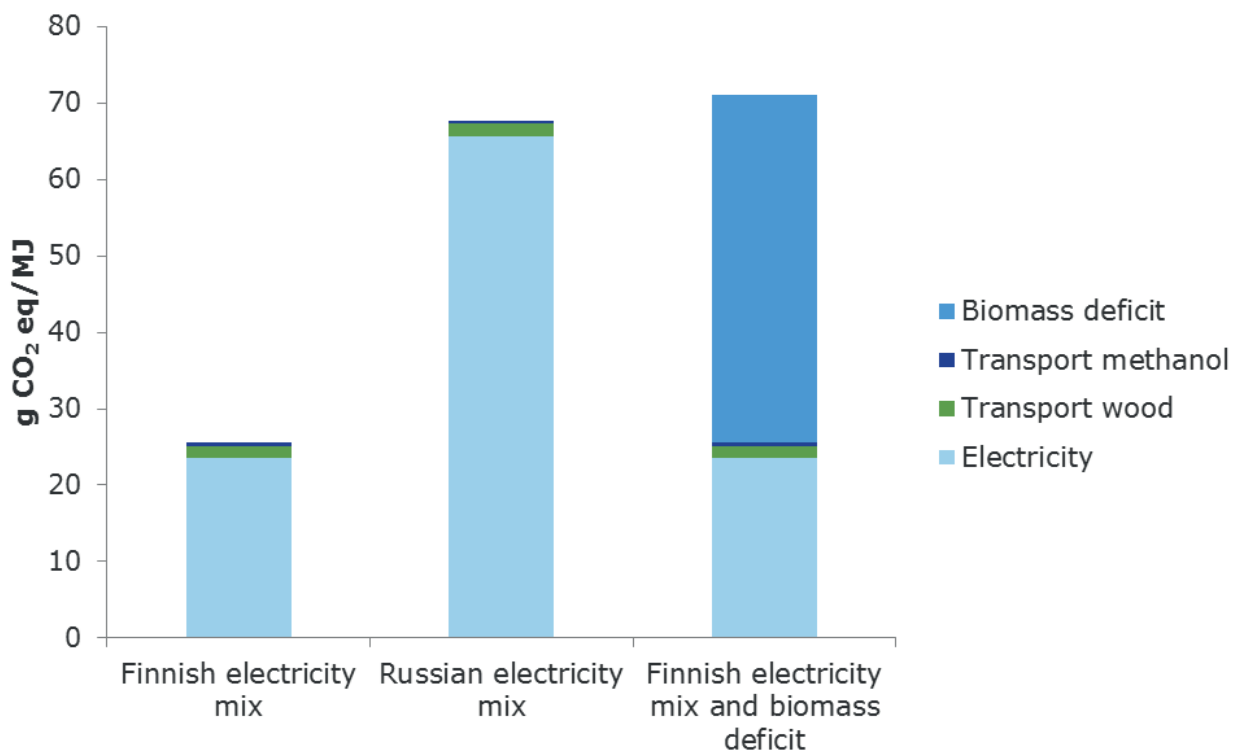

**Figure 4-4:** CO<sub>2</sub> emissions for electricity mixes of various countries

Finland, Sweden and Russia are shown here as examples due to their large biomass availability.

Besides the emissions from electricity, additional emissions may arise when the waste biomass from a mill is not sufficient to fulfil the biomass needs of methanol production, and this deficit is filled by burning fossil fuels to create enough black liquor. Additionally, transportation of biomass and methanol will generate emissions.

The lifecycle GHG emissions of bio-methanol production are modelled in the DNV GL study the *Fuel Trilemma*<sup>13/</sup>, based on electricity need of 2.1 MWh/tonne of methanol. GHG emissions from electricity mixes are taken from the IEA. In order to model the emissions in the case of a plant with a biomass deficit, a 15% additional biomass demand is assumed to be filled by burning residual fuel oil. Figure 4-5 shows the results of lifecycle emissions from biomass methanol production, using the Finland energy mix and the Russian energy mix. Results for a plant with a biomass deficit which must be filled using residual fuel oil are also shown.



**Figure 4-5:** Well-to-tank GHG emissions of methanol produced from biomass

Direct GHG emissions generated from the combustion of synthesis gas from biomass and the combustion of methanol from bio-methanol are considered climate neutral, and they are therefore not included in the lifecycle emissions. Bio-methanol produced with a clean electricity mix has therefore a potential to have low GHG emissions. Comparing Figure 4-3 to Figure 4-5 shows that the well-to-tank emissions of producing methanol with biomass are not much lower than with natural gas. However, the combustion of bio-methanol and methanol produced with natural gas will result in fewer GHG emissions. (This will be discussed in greater detail in section 4.4.)

## 4.2 Combustion of methanol on board ships

The actual CO<sub>2</sub> emissions from combustion of methanol are based on the carbon content per MJ fuel. The carbon content can vary slightly according to the purity of fuel; however, purity of the product is well controlled in the production process. This study uses as a basis that methanol combustion emits 69 g CO<sub>2</sub> per MJ methanol combusted<sup>9/</sup>.

CO<sub>2</sub> from combusted bio-methanol is considered climate neutral<sup>2</sup> and is therefore not considered a GHG gas. This is because it is assumed that CO<sub>2</sub> emitted from biomass-based fuel is removed from the atmosphere once new biomass grows to replace the biomass used to produce the fuel. CH<sub>4</sub> and N<sub>2</sub>O emissions from methanol are assumed to be negligible<sup>12/</sup>.

SO<sub>x</sub> emissions are based on sulphur content of methanol, which is negligible<sup>12/</sup>.

There have been few tests measuring the NO<sub>x</sub> emissions from methanol combusted in marine engines. Wärtsilä has tested NO<sub>x</sub> emissions from methanol against those from HFO in two engine models: pre-tests on the Wärtsilä Vasa 32, and full tests on the Sulzer Z40S-MD<sup>14/</sup>. Their results show that NO<sub>x</sub> emissions were approximately 40% of emissions from HFO from the same engines at similar load. However, the NO<sub>x</sub> emissions were not as low as Tier III levels. It is therefore assumed that NO<sub>x</sub> emissions during combustion are reduced by approximately 60% when running on methanol compared to HFO. MAN Diesel has performed tests with a methanol in marine diesels resulting in a 30% reduction in NO<sub>x</sub> emissions compared to diesel<sup>15/</sup>.

<sup>2</sup> Although CO<sub>2</sub> emissions from biofuels, including bio-methanol, are considered to be climate neutral from a lifecycle assessment perspective, they are not necessarily considered climate neutral when calculating the CO<sub>2</sub> emissions of methanol propulsion for the EEDI regulation (see section 3.1).

(Although the results of tests from Wärtsilä<sup>/14/</sup> and MAN<sup>/15/</sup> differ, both indicate a significant decrease in NO<sub>x</sub> reduction when using methanol. Additionally, NO<sub>x</sub> emissions are dependent on combustion condition, meaning that any parameter indicating NO<sub>x</sub> emissions per MJ fuel will contain some uncertainty.)

The Wärtsilä tests also indicated that the fuel efficiency is the same or better when running on methanol. Stena’s experience indicates that they have better fuel efficiency in the order of 1-2% when running on methanol, although they have not performed tests to document the change in efficiency. It is therefore assumed that the energy efficiency in marine engines remains unchanged when running on methanol. There is increased lubrication oil consumption when running on methanol, but this was considered negligible.

The following combustion factors for methanol are employed. All factors depend on engine type to a certain extent.

**Table 4-2:** Emissions factors for methanol combustion in marine engines

| Compound         | Emissions (g/MJ methanol) | Source |
|------------------|---------------------------|--------|
| CO <sub>2</sub>  | 69                        | /12/   |
| CH <sub>4</sub>  | 0                         | /12/   |
| N <sub>2</sub> O | 0                         | /12/   |
| NO <sub>x</sub>  | 0.4                       | /14/   |
| SO <sub>x</sub>  | 0                         | /12/   |

### 4.3 Lifecycle emissions of conventional fuels

The lifecycle emissions of conventional fuels, HFO and MGO, are based on well-to-tank: extraction and transport of raw materials (crude oil), refining, bunkering and storage of the fuel, and tank-to-propeller: combustion on board a vessel. The emissions from each phase are normalized per MJ fuel.

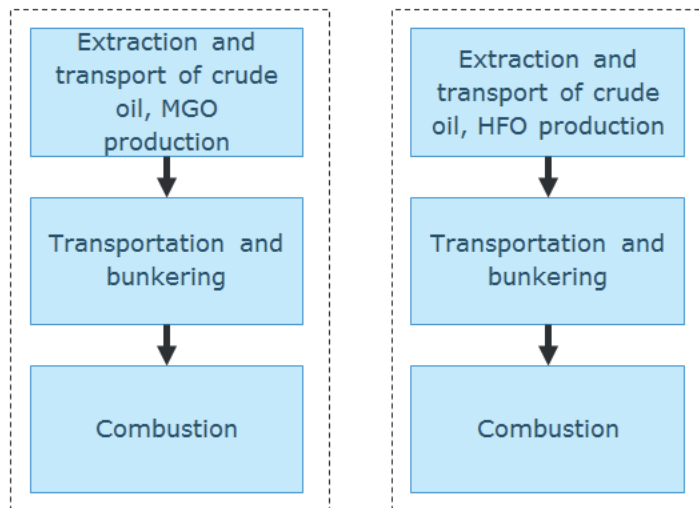

**Figure 4-6:** Map of lifecycle phases of HFO and MGO production and use in ships

Values for relevant emissions from the well-to-tank part of the lifecycle are based on the ELCD Core database<sup>/16//17/</sup>. This database includes environmental inputs and emissions for the necessary processes used to make HFO and MGO. The resulting values are representative for HFO and MGO produced in Europe<sup>/9/</sup>.

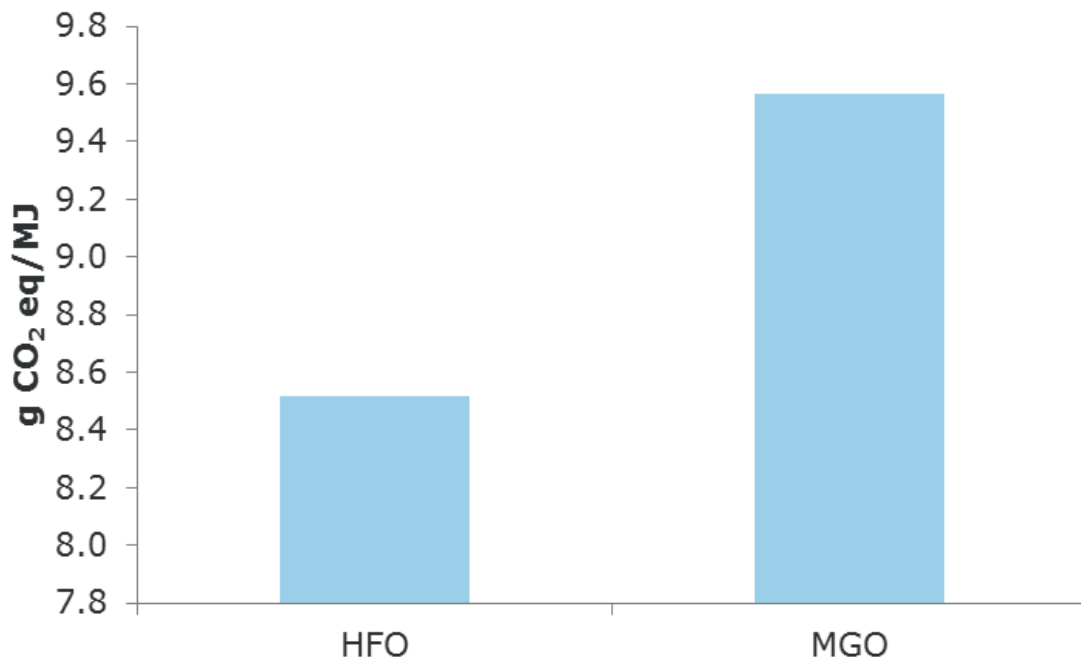

**Figure 4-7:** Well-to-tank GHG emissions of HFO and MGO

The higher well-to-tank GHG emissions of MGO compared to HFO are due to the emissions from refining MGO.

Table 4-3 shows the emissions factors from MGO and HFO when combusted in marine engines. CO<sub>2</sub> and SO<sub>x</sub> factors are based on carbon and sulphur content of fuel. SO<sub>x</sub> HFO and MGO factors are based on 1% sulphur and 0.1% sulphur respectively.

The emissions of NO<sub>x</sub> also tend to differ according to MGO and HFO because MGO and HFO are run on different types of ships with different engine configurations. Slow-speed two stroke engines have higher NO<sub>x</sub> emissions due to longer times at higher temperatures and pressures because of their lower engine revolutions. The same emission NO<sub>x</sub> factors are therefore used in this study for MGO and HFO.

Emission factors are based on emissions from ro-ro vessels.

**Table 4-3:** Emissions factors for MGO and HFO combustion in marine engines<sup>9/</sup>

| Compound         | MGO emissions (g/MJ MGO) | HFO emissions (g/MJ HFO) |
|------------------|--------------------------|--------------------------|
| CO <sub>2</sub>  | 75                       | 77                       |
| CH <sub>4</sub>  | 0                        | 0                        |
| N <sub>2</sub> O | 0                        | 0                        |
| NO <sub>x</sub>  | 1                        | 1                        |
| SO <sub>x</sub>  | 0.04                     | 0.5                      |

## 4.4 Comparing lifecycle emissions of methanol to conventional fuels

### 4.4.1 Greenhouse gas emissions

Figure 4-8 shows the breakdown of GHG emissions from each lifecycle phase of methanol production with natural gas.

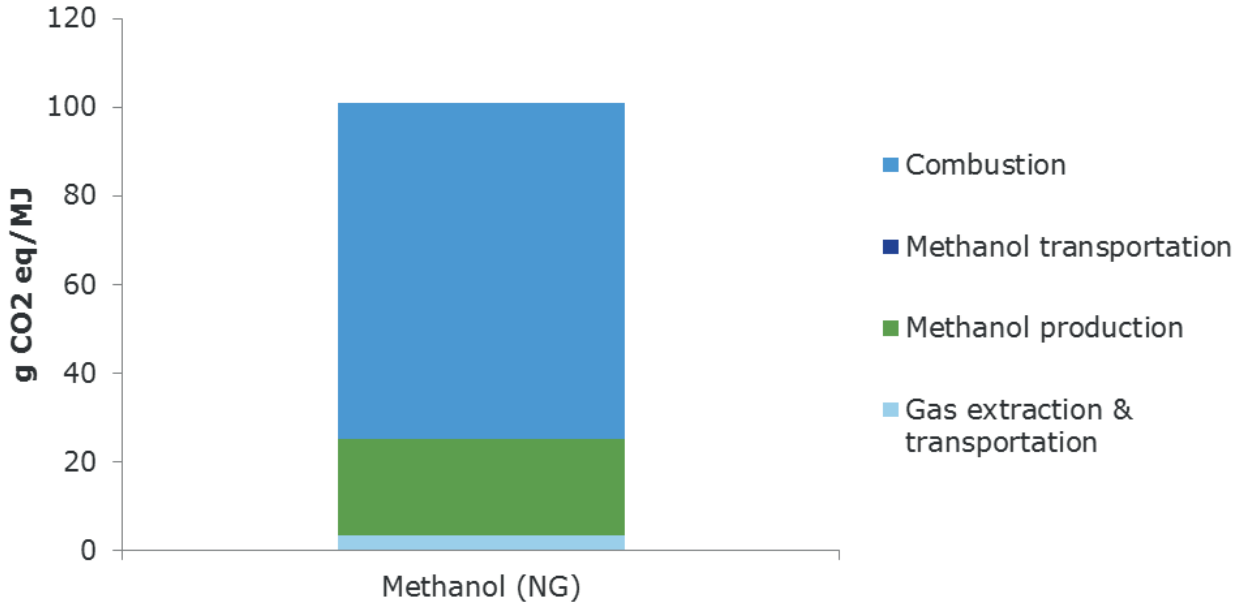

**Figure 4-8:** Breakdown of GHG emissions according to lifecycle phase from methanol produced with natural gas

The lifecycle emissions from methanol production with natural gas are dominated by emissions from methanol production and combustion in marine engines.

Since emissions from methanol combustion and methanol production at the plant are based on the chemical composition of natural gas and methanol respectively, there is little variation regarding these emissions. The emissions from extraction and transport of natural gas can vary significantly according to where the natural gas is produced. However, these emissions are small compared to those from combustion and production.

Figure 4-9 shows that emissions from the well-to-tank phase of methanol produced with natural gas are slightly higher than corresponding emissions from MGO and HFO. For comparison, the lifecycle emissions of LNG from well-to-propeller are found to be from 72-90 g CO<sub>2</sub> eq/MJ, meaning that the lifecycle GHG emissions of LNG are in the order of magnitude of conventional fuels.

Provided that biomass is produced using a relatively clean electricity mix, the lifecycle GHG emissions of methanol production are less than half of conventional fuels.

The environmental benefits of methanol are highly dependent on the raw materials used to make it. Even bio-methanol is not necessarily much improved over MGO if it is made with an electricity mix that does not have a high share of renewables.

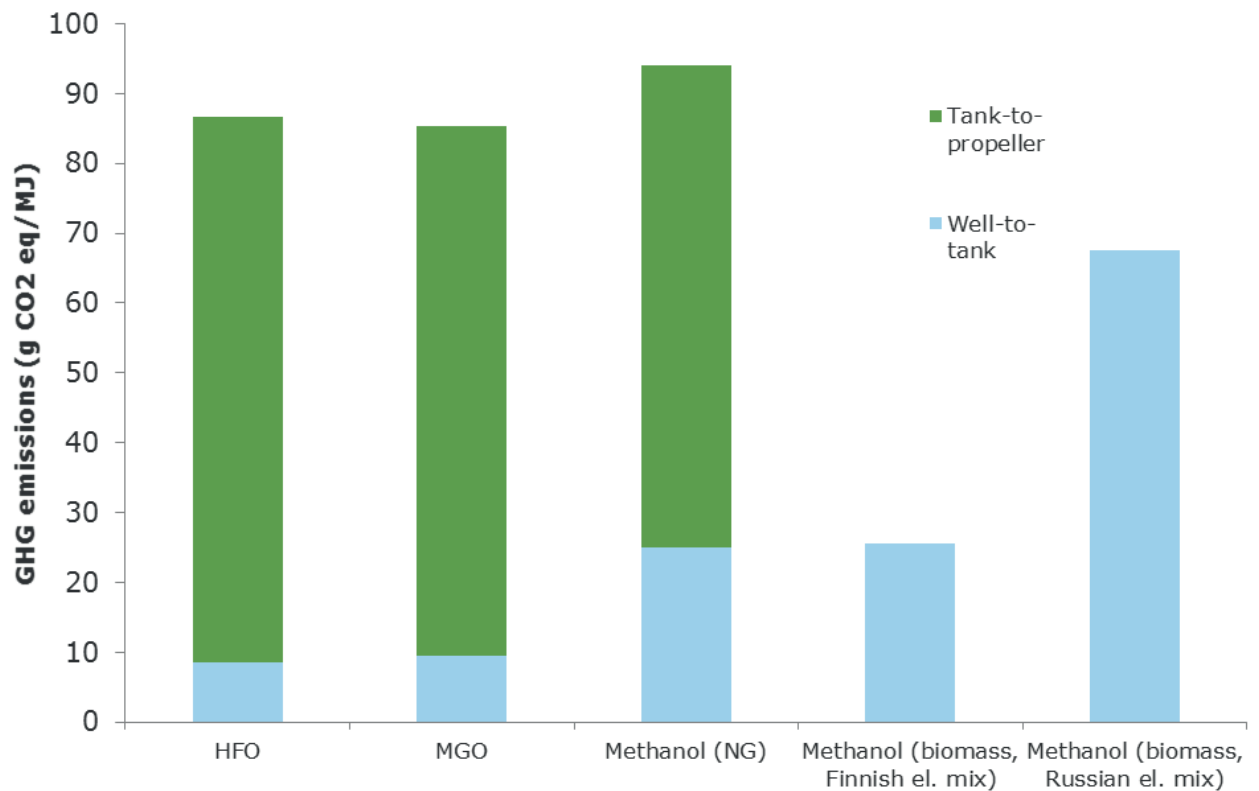

**Figure 4-9:** Lifecycle emissions for methanol produced using natural gas and biomass, compared to conventional fuels

#### 4.4.2 Lifecycle NO<sub>x</sub> and SO<sub>x</sub> emissions

The lifecycle emissions of SO<sub>x</sub> and NO<sub>x</sub> have also been calculated based on the ELCD database<sup>9/</sup>, and information in Table 4-2 and Table 4-3. The emissions of SO<sub>x</sub> and NO<sub>x</sub> from the well-to-tank production of bio-methanol are based on values for methanol produced from biomass via black liquor (Brynolf, Fridell, & Andersson, 2014)<sup>9/</sup>.

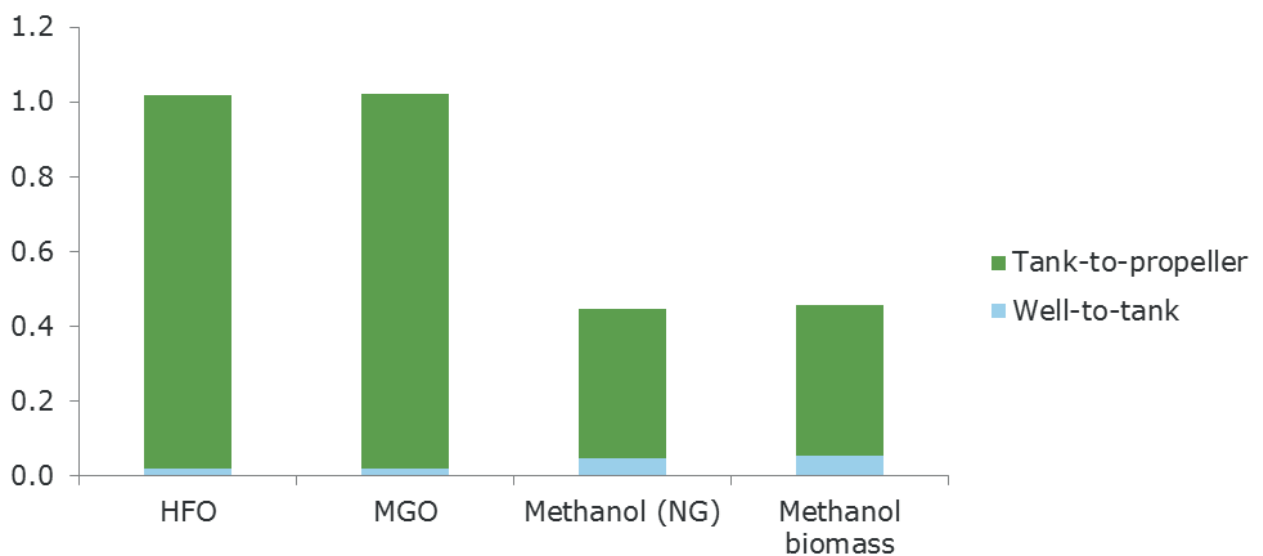

**Figure 4-10:** Lifecycle emissions of NO<sub>x</sub> from methanol compared to conventional fuels

The lifecycle emissions of NO<sub>x</sub> are reduced by approximately 55% when using methanol compared to conventional fuels.



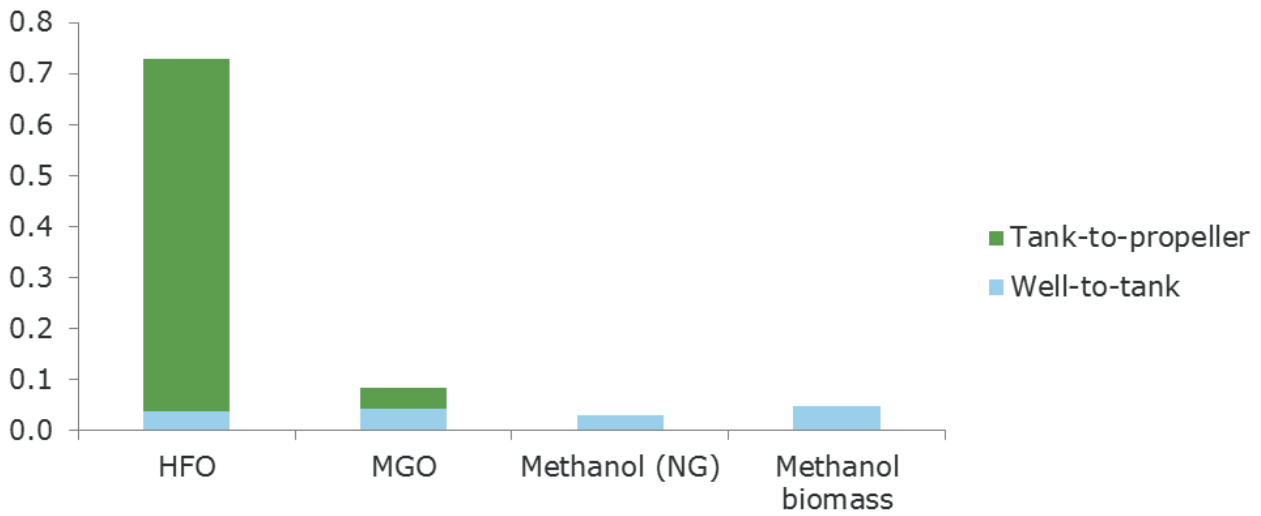

**Figure 4-11:** Lifecycle emissions of  $SO_x$  from methanol compared to marine conventional fuels

The lifecycle emissions of  $SO_x$  are reduced by approximately 92% when using methanol, compared to conventional fuels.

Figure 4-10 and Figure 4-11 illustrate that the  $NO_x$  and  $SO_x$  emissions are dominated by the combustion in marine engines, and that implementing measures which reduce  $NO_x$  and  $SO_x$  from ships is an effective way to reduce these types of emissions on a global level.

# 5

## Identification of technology readiness

### 5.1 Introduction

The IMO's International Code of Safety for Ships using Gases or other Low-flashpoint Fuels (IGF Code)<sup>/18/</sup>, is to provide an international standard for ships using low-flashpoint fuel. The basic philosophy of this Code is to provide mandatory provisions for the arrangement, installation, control and monitoring of machinery, equipment and systems using low-flashpoint fuel to minimize the risk to the ship, its crew and the environment, having regard to the nature of the fuels involved. The IGF Code will not be in force until January 2017 and will include requirements regarding methanol as fuel at a later stage. Despite this the various flag States are relating to the IGF Code, since it is adopted by IMO.

According to the IGF Code the overall functional requirement is: *the safety, reliability and dependability of the systems shall be equivalent to that achieved with new and comparable conventional oil-fuelled main and auxiliary machinery*. This level of safety is found by conducting a risk assessment, hazard identification (HAZID) or failure mode, effect and criticality analysis (FMECA), of the fuel system. This is carried out in the design phase, to avoid risks and implement additional risk reducing measures in the design if the risk level is found to be high.

The IGF Code has been adopted by various Classification Societies and class-rules have been developed based on several years of experience. An extract of the requirements in DNV GL Rules for Low Flashpoint Liquid Fuelled Engines<sup>/19/</sup>, and the possible risk reduction measures which may be implemented are therefore used as basis in this study. The assessment will further be structured into system elements of the methanol fuel system and the main differences for certain ship types will be highlighted.

### 5.2 System breakdown

The assessment is further divided into the following system elements:

- Bunkering of methanol
- Storage of methanol on board
- Methanol handling and processing towards the main engine
- Combustion of methanol in the main engine
- Methanol handling and processing after the main engine

These system elements constitute the whole methanol fuel system, which is presented in Figure 5-1 and further discussed in the following sections.

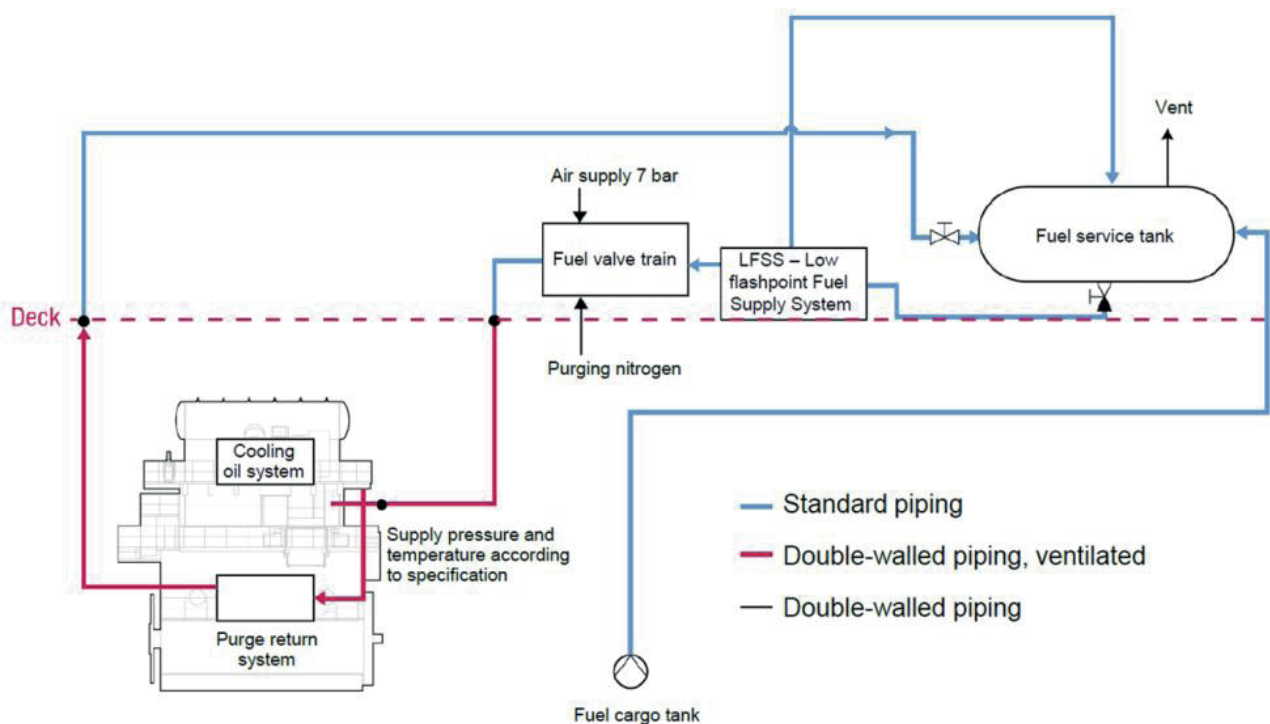

Figure 5-1: Schematic overview of the methanol fuel system<sup>20/</sup>

Safety aspects and technology scope may be different for different ship types, due to the purpose and design of the ship. These differences will be highlighted by dividing into three different ship types, in the following breakdown:

- Working ships, e.g. offshore supply vessels
- Cargo ships, e.g. tankers and bulk carriers
- Passenger ships, e.g. cruise ships and ferries

### 5.2.1 Bunkering of methanol

Requirements regarding bunkering of methanol are according to DNV GL rules<sup>19/</sup> divided into the bunkering station and the fuel bunkering system individually:

#### **Fuel bunkering station:**

- The bunkering station shall be so located that sufficient natural ventilation is provided. The bunkering station shall be separated from other areas of the ship by gas tight bulkheads, except when located in the cargo area on tankers. Closed or semi-enclosed bunkering stations will be subject to special consideration with respect to requirements for mechanical ventilation.
- Coamings shall be fitted below the bunkering connections.
- Control of the bunkering shall be possible from a safe location in regard to bunkering operations. At this location the tank level shall be monitored. Overfill alarm and automatic shutdown is also to be indicated at this location.

#### **Fuel bunkering system:**

- A manually operated stop valve and a remote operated shutdown valve in series, or a combined manually operated and remote valve shall be fitted in every bunkering line close to the shore connecting point.
- Bunkering pipes shall be self-draining.
- Bunkering lines shall be arranged for inerting and gas freeing.
- The connecting coupling for the transfer hose shall be of a type which automatically closes at disconnection (self-sealing type).

None of these aspects are of a new and complicated nature. These systems already exist in many applications, e.g. for several ships using LNG as fuel within different ship segments. This system breakdown is therefore considered as mature technology.

### Addressed safety aspects:

The configuration of the bunkering station and bunkering system is more comprehensive compared to conventional fuel oil, due to the nature of methanol as a fuel and its chemical and physical properties. Methanol is toxic and has a low flashpoint of only 12°C. Flashpoint is the minimum temperature at which a liquid gives off vapour in sufficient concentration to form an ignitable mixture with air. This methanol property in combination with a low needed ignition energy results in additional control barriers. Additional monitoring and control systems are therefore needed, such as overfill alarms, automatic shutdown, monitoring of ventilation and gas detection, which is stated in the rules presented above.

These safety barriers are also meant to minimize methanol exposure to personnel, due to its toxic properties. Methanol is toxic if swallowed, comes in contact with skin or if vapour is inhaled. If methanol is ingested in relatively large quantities it will be metabolized to formic acid or formate salts, which is poisonous to the central nervous system and may cause blindness, coma and death. The high toxicity level implies that if as little as 10 mL of pure methanol is ingested, it can break down into formic acid, which can cause permanent blindness by destruction of the optic nerve. 30 mL is potentially fatal, although the median lethal dose is about 100 mL. The toxic effects take hours to start, and effective antidotes can often prevent permanent damage.

### 5.2.2 Storage of methanol on board

Storage of methanol on board is outlined in the schematic overview of the methanol fuel system presented in Figure 5-2. This part of the methanol fuel system consists of a fuel cargo tank in addition to a fuel service tank placed on deck. This is not the only possible solution regarding storage of methanol as fuel, but used as example in this study for illustration purposes.

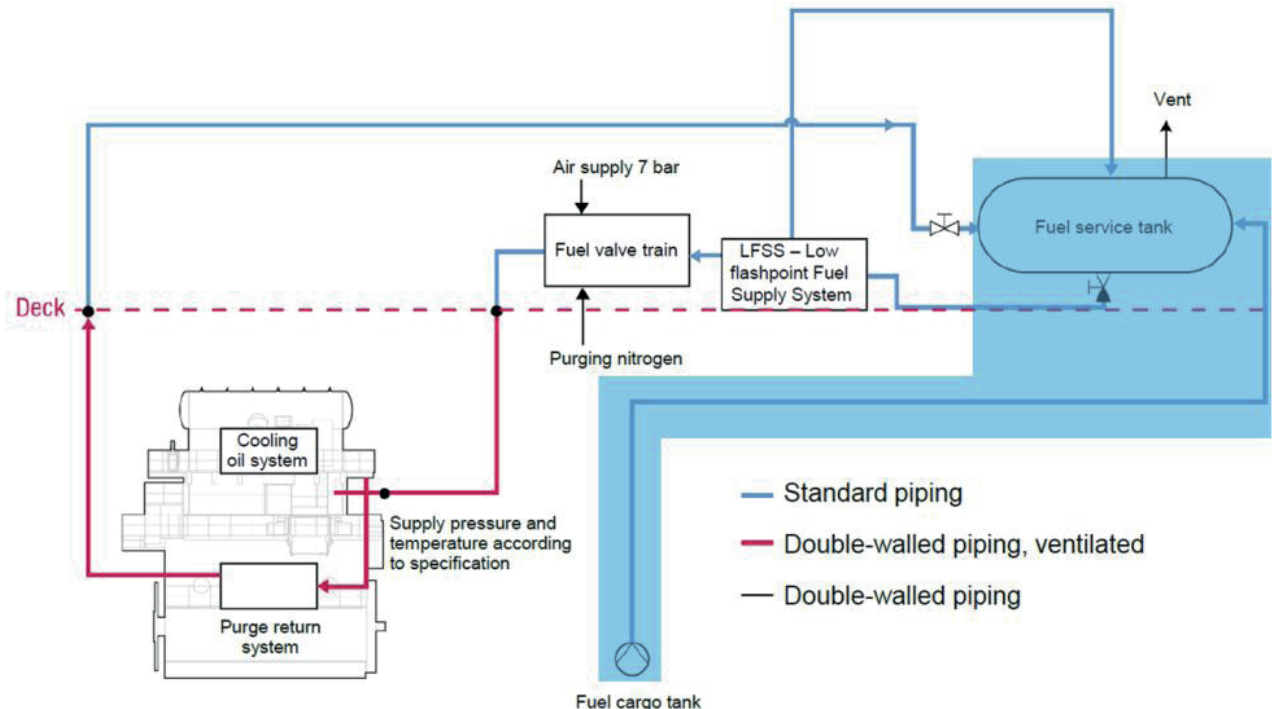

Figure 5-2: Storage of methanol on board<sup>20/</sup>

Requirements regarding storage of methanol according to DNV GL rules<sup>19/</sup> are divided into location of fuel tanks, protection of fuel tanks, gas freeing, inerting, venting of fuel tanks and special concerns regarding tanks placed on weather decks.

**Location of fuel tanks:**

- Fuel shall not be stored within machinery spaces or accommodation spaces and the minimum horizontal distance between the fuel tank side and the ship's shell shall be at least 760 mm.
- The spaces forward of the collision bulkhead (forepeak) and aft of the aftermost bulkhead (afterpeak) shall not be arranged as fuel tanks.
- Two fuel service tanks for each type of fuel used on board necessary for propulsion and vital systems or equivalent arrangements shall be provided.
- Each tank shall have a capacity sufficient for continuous rating of the propulsion plant and normal operating load at sea of the generator plant for a period of not less than 8 hours, if only methanol is used as fuel.

**Protection of fuel tanks located inside the ship hull:**

- Where not bounded by bottom shell plating or fuel pump room, the fuel tanks for Low Flashpoint Liquid (LFL) shall be surrounded by protective cofferdams.
- The protective cofferdam surrounding the LFL fuel tank shall be arranged with vapour and liquid leakage detection and possibility for water filling upon detection of leakage. The water filling shall be through a system without permanent connections to water systems in non-hazardous areas. Emptying shall be done with a separate system. Bilge ejectors serving hazardous spaces shall not be permanently connected to the drive water system.

**Gas freeing, inerting and venting of fuel tanks:**

- Fuel tanks shall be provided with an arrangement for safe inert gas purging and gas freeing.
- Fuel tanks without direct access from open deck shall have a sufficient number of ventilation inlets and outlets to ensure complete gas freeing, but no less than 2 inlets and 2 outlets per tank.
- The tanks shall have an arrangement for pressure/vacuum relief or equivalent during voyage, bunkering and fuel transfer with closed tank hatch covers.
- Individual pressure vacuum relief valves or an equivalent arrangement shall be fitted to each tank to limit the pressure or vacuum in the tank.
- The venting system shall be designed with redundancy for the relief of full flow overpressure and vacuum. Pressure sensors fitted in each fuel tank, and connected to an alarm system, may be accepted in lieu of the redundancy requirement for pressure relief.
- Pressure/vacuum safety valves shall be located on open deck and shall be of a type which allows the functioning of the valve to be easily checked.
- Intake openings of pressure/vacuum relief valves shall be located at least 1.5 m above tank deck, and shall be protected against the sea.
- The vent system shall be sized, allowing for flame screens, if fitted, to permit bunkering at a design rate without over-pressuring the tank. Specifically, under conditions in which a saturated fuel vapour is discharged through the venting system at the maximum anticipated bunkering rate, the pressure differential between the fuel tank vapour space and the atmosphere shall not exceed the design vapour pressure of the tank, or, for independent tanks, the maximum working pressure of the tank.
- The venting system shall be connected to the highest point of each fuel tank and vent lines shall be self-draining under all normal operating conditions of list and trim.
- The arrangement for gas freeing fuel tanks shall be such as to minimize the hazards due to the dispersal of flammable vapours in the atmosphere and to flammable vapour mixtures in a fuel tank. The ventilating system used for gas freeing of fuel tanks shall be used exclusively for ventilating purposes.

**Fuel tanks on weather deck:**

- LFL fuel tanks on open deck shall be protected against mechanical damage.
- LFL deck tanks on open deck shall be surrounded by coamings.
- Special considerations shall be taken to minimize any fire hazards adjacent to the fuel tanks on weather deck. Protection of the LFL fuel tanks from possible fires on board may be subject to a fire safety assessment in each particular case.

The requirements regarding placement and protection of tanks may imply that additional space must be allocated for storage of methanol on board. The requirements regarding gas freeing, inerting and venting of the tanks involve fitting of equipment, such as pressure/vacuum relief valves, shut-off valves, venting system and pressure sensors connected to alarms. These are all well-known systems and components and are used all over the maritime industry, but may involve an increased installation cost. As opposed to fuel oil, methanol properties enable storage of methanol in double bottom tanks, since it is not considered harmful to the environment.

**Addressed safety aspects:**

The configuration of the methanol fuel storage tank is more complex compared to conventional fuel oil, due to the nature and properties of methanol as a fuel. Additional monitoring and control systems are needed, such as overfill alarms and shutdown, monitoring of ventilation liquid and gas detection. Fire detection systems in spaces adjacent to fuel storage and firefighting systems are also needed. Especially fire detection systems are important, due to the fact that a methanol-based fire burns invisibly, unlike gasoline, which burns with a visible flame. Fire detection with infrared cameras is therefore a possible solution to this problem in combination with water spray firefighting systems.

**5.2.3 Handling and processing of methanol towards the main engine**

Handling and processing of methanol towards the main engine is outlined in the schematic overview of the system presented in Figure 5-3. This part of the fuel system consists of a fuel supply system and a fuel valve train placed on deck.

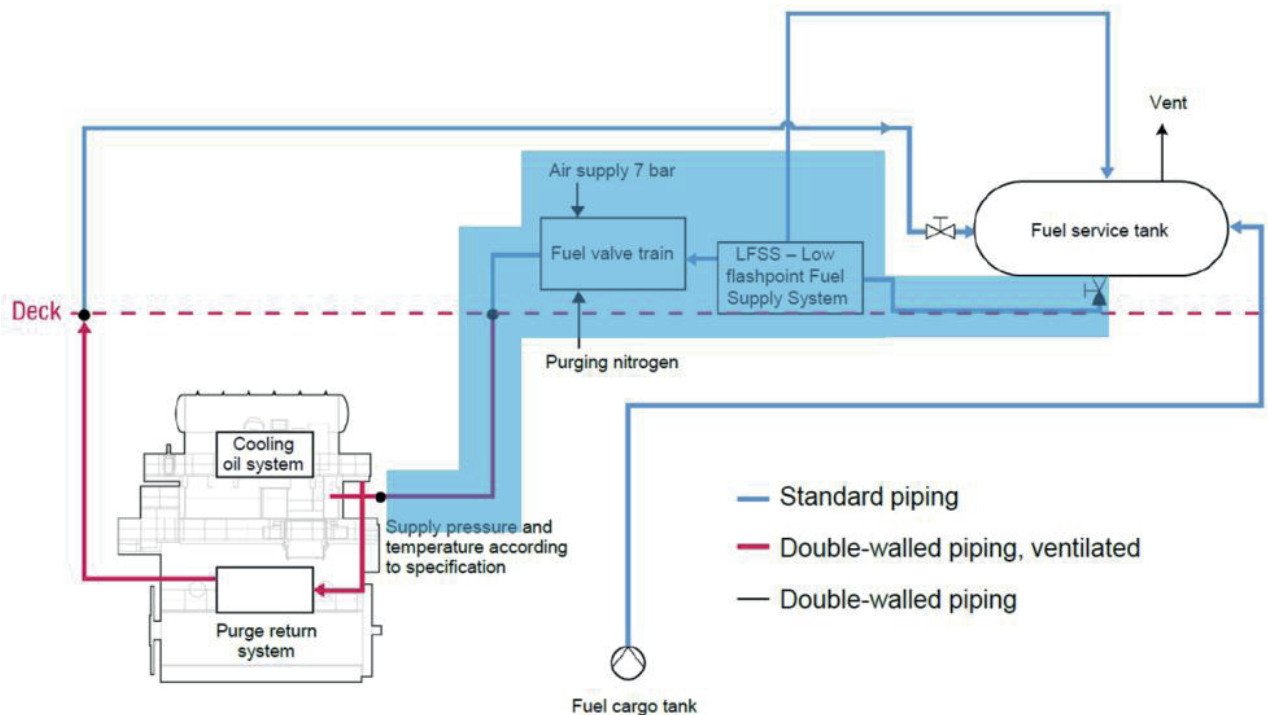

**Figure 5-3:** Handling and processing of methanol towards the main engine<sup>20/</sup>

Requirements regarding handling and processing of methanol towards the main engine according to DNV GL rules<sup>19/</sup> are divided into general issues, protection of fuel transfer system, valves, fuel pumps and temperature control.



**General:**

- The fuel system shall be entirely separate from all other piping systems on board.
- The piping shall be located no less than 760 mm from the ship side.
- For vessels using LFL as their only fuel, the fuel supply system shall be arranged with redundancy and segregation all the way from the fuel tank to the consumer, so that a leakage in the fuel supply system with following necessary safety actions does not lead to loss of propulsion, power generation or other main functions.
- All piping containing LFL shall be arranged for gas freeing and inerting.
- The design pressure  $p$  is the maximum working pressure to which the system may be subjected. The design pressure for fuel piping is as a minimum to be taken as 10 bar. Due consideration shall be given to possible liquid hammer in connection with the closing of valves.
- Drip trays shall be installed below all possible leakage points in the fuel system.

**Protection of fuel transfer system:**

- Fuel piping shall be protected against mechanical damage.
- All piping containing LFL that passes through enclosed spaces in the ship shall be enclosed in a pipe that is gas tight and water tight towards the surrounding spaces with the LFL contained in the inner pipe.
- Fuel piping shall normally not be led through accommodation spaces, service spaces or control stations. In cases where fuel piping must be led through accommodation spaces, the double walled fuel piping shall be led through a dedicated duct. The duct shall be of substantial construction and be gas tight and water tight.
- The annular space in the double walled fuel pipe shall be ventilated to open air and be equipped with vapour and liquid leakage detection. Inerting of the annular space in the double walled fuel piping may be accepted as an alternative in low pressure fuel systems. The inerted annular space shall be pressurized with inert gas at a pressure greater than the fuel pressure. Suitable alarms shall be provided to indicate a loss of inert gas pressure between the pipes.

**Valves:**

- LFL storage tank inlets and outlets shall be provided with remotely operated shut-off valves located as close to the tank as possible. The tank valve shall automatically cut off the LFL supply.
- Valves that are required to be operated during normal operation and which are not accessible shall be remotely operated. Normal operation in this context is when fuel is supplied to consumers and during bunkering operations.
- The main supply lines for fuel to each engine room shall be equipped with automatically operated master LFL fuel valves. The shut-off valve shall be situated outside the engine room. The master LFL fuel valve shall automatically cut off the LFL supply to the engine room.
- The LFL fuel supply to each consumer shall be provided with a remote shut-off valve.
- There shall be one manual shutdown valve in the LFL supply line to each engine to assure safe isolation during maintenance on the engine.
- All automatic and remotely operated valves are to be provided with indications for open and closed valve positions at the location where the valves are remotely operated.

**Fuel pumps:**

- Any pump room shall be located outside the engine room, be gas tight and water tight to surrounding enclosed spaces and vented to open air.
- Hydraulically powered pumps that are submerged in fuel tanks (e.g. deep well pumps) shall be arranged with double barriers preventing the hydraulic system serving the pumps from being directly exposed to the fuel.

- The double barrier shall be arranged for detection and drainage of possible fuel leakages.
- LFL pump rooms shall be provided with a dedicated bilge system, operable from outside the pump room. Bilge ejectors serving hazardous spaces shall not be permanently connected to the drive water system. The bilge system may have possibilities for discharge to a suitable cargo tank, slop tank or similar, however, taking into account hazards related to incompatibility.

**Temperature control:**

- The temperature control system shall be arranged as a secondary system independent of other ship's services and shall be provided with valves to isolate the system for each supply line or tank.
- For any temperature control system, means shall be provided to ensure that, when in any other but the empty condition, a higher pressure is maintained within the system than the maximum pressure head exerted by the fuel tank content on the system.
- The temperature control circuit expansion tank shall be fitted with a gas detector and low level alarm and be vented to open air.

The configuration of the methanol fuel transfer and supply arrangement, from the methanol storage tank towards the main engine, is more complex compared to conventional fuel oil transfer systems. The main contributor to the complexity is the piping arrangement with double walled piping including needed gas freeing and inerting capabilities, ventilation of annular space with vapour and liquid leakage detection. Added complexity is also due to remotely operated shut-off valves to the tanks, valves operated during normal operation and LFL fuel supply valves to each consumer with their corresponding control system. The added complexity may involve an increased installation cost.

**Addressed safety aspects:**

The requirements regarding methanol fuel transfer and supply from the methanol storage tank towards the main engine is more complex, as mentioned above, due to the physical properties of methanol. Methanol has a flashpoint of about 12°C, which is the minimum temperature methanol gives off vapour in sufficient concentration to form an ignitable mixture with air. Double walled piping with sufficient ventilation, in addition to segregation by remotely operated valves throughout the whole supply system is therefore needed. Methanol vapour is heavier than air and it will therefore move downwards, hence the placement of gas detectors and ventilation at lower elevations is essential.

There are many valves and pipe connections throughout the methanol handling and processing system. This implies that there are many potential leakage points in the system which need attention, due to the low viscosity of methanol. This is mainly considered by selecting seals and similar with the correct material properties.

#### **5.2.4 Combustion of methanol in the main engine**

Combustion of methanol in the main engine is outlined in the schematic overview of the system presented in Figure 5-4. This part of the methanol fuel system consists of additional methanol booster injectors, a liquid gas injection block fitted on the cylinder, which contains a control valve for methanol fuel injection, a sealing booster activation valve, a forced suction activation valve, a purge valve and methanol fuel inlet/outlet valves.

Requirements regarding combustion of methanol in the main engine according to DNV GL rules<sup>/19/</sup> is divided into general issues, functional requirements for dual fuel engines and functional requirements for LFL-only engines.



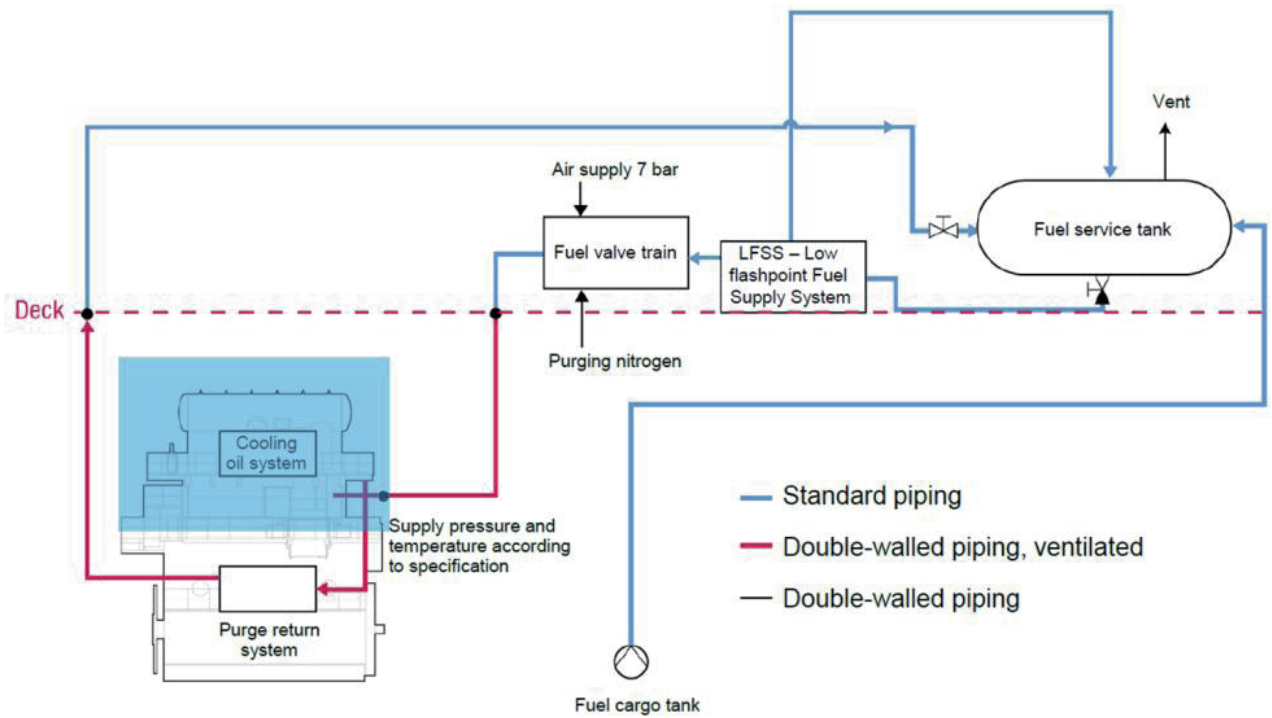

Figure 5-4: Combustion of methanol in the main engine<sup>[20]</sup>

**General, which applies to both LFL fuel only and dual fuel engines:**

- Measures shall be taken to ensure effective sealing of injection or admission equipment that could potentially leak fuel into the engine room.
- Measures shall be taken to ensure that LFL fuel injection pumps and injection devices are efficiently lubricated.
- The starting sequence must be such that LFL fuel is not injected or admitted to the cylinders until ignition is activated and the engine has reached a minimum rotational speed. In this respect pilot fuel is needed.
- If ignition has not been detected by the engine monitoring system within expected time after activation of fuel admission or injection valve, the LFL fuel supply shall be automatically shut-off and the starting sequence terminated.

**Functional requirements for dual fuel engines:**

- LFL dual fuel engines shall be able to start, normal stop and stable low power operation safely. In case of shut-off of the LFL fuel supply, the engine shall be capable of continuous operation on oil fuel only.
- Changeover to and from LFL fuel operation is only to be possible at a power level where it can be done with acceptable reliability as demonstrated through testing. On completion of preparations for changeover to LFL operation including checks of all essential conditions for changeover, the changeover process itself shall be automatic.
- On normal shutdown as well as emergency shutdown, LFL fuel supply shall be shut-off not later than simultaneously switching to oil fuel mode.
- Firing of the LFL-air mixture in the cylinders shall be initiated by sufficient energy to ensure effective ignition with corresponding combustion of the LFL-air mixture. It shall not be possible to shut-off the ignition source without first or simultaneously closing the LFL fuel supply to each cylinder or to the complete engine.

### Functional requirements LFL-only engines:

- One single failure in the LFL fuel supply system shall not lead to total loss of fuel supply.

Development of LFL fuel engines have been carried out since 2012, by MAN Diesel & Turbo<sup>/21/</sup> and Wärtsilä<sup>/22/</sup>. The MAN B&W ME-LGI engine is a dual fuel solution for low flashpoint liquid fuels. Fuel injection is accomplished by a booster fuel injection valve, using 300 or more bar hydraulic power to raise the fuel pressure to injection pressure. So far seven chemical tankers of this engine configuration have been ordered, meaning that this configuration is at a relatively early stage in development.

The use of methanol also presents lubrication requirements that are substantially different than those of conventional fuels. Using methanol as a fuel generally promotes a cleaner lubricant environment, but induces significantly greater engine wear compared to fuel oil. This wear may affect engine operation and durability.

### 5.2.5 Methanol handling and processing after the main engine

Handling and processing of methanol after the main engine is outlined in the schematic overview of the system presented in Figure 5-5. This part of the system consists of a purge return system, throughout the entire fuel system.

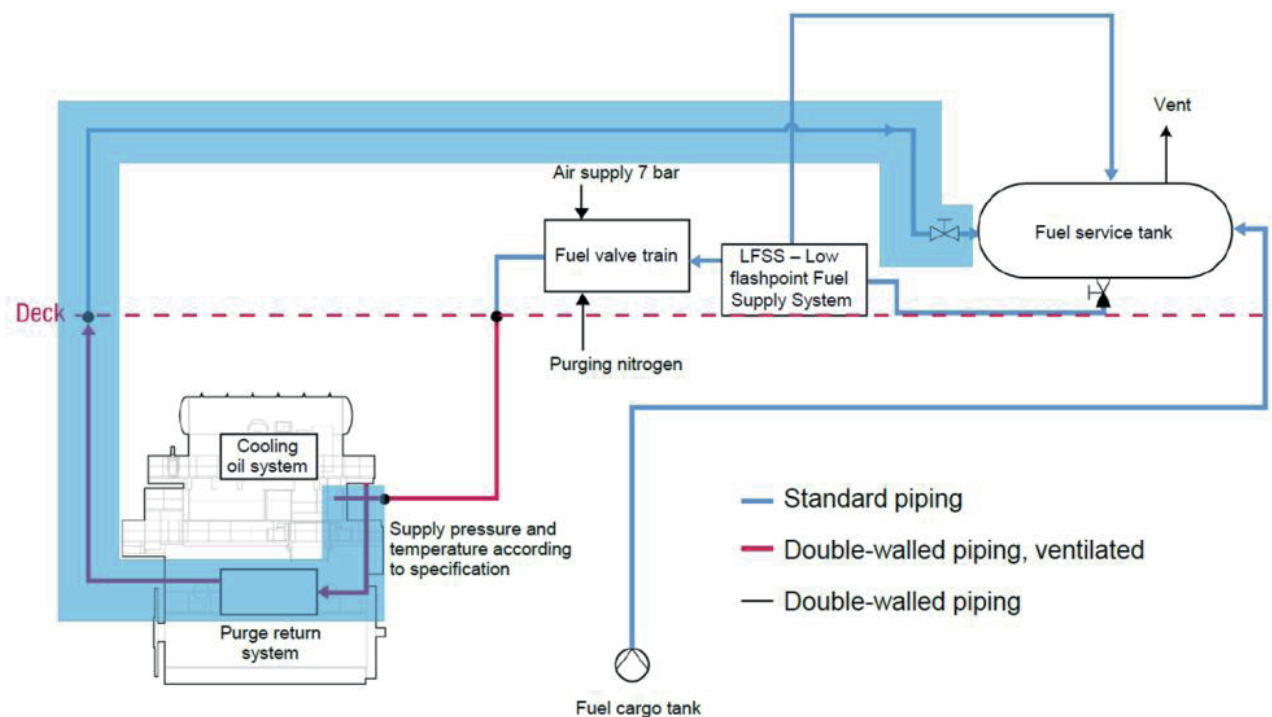

Figure 5-5: Handling and processing of methanol after the main engine<sup>/20/</sup>

Functional requirements regarding gas freeing and inerting of the methanol fuel system are found in several sections in the DNV GL Rules for Low Flashpoint Liquid Fuelled Ship Installations<sup>/19/</sup>. Especially the two following:

- All piping containing LFL shall be arranged for gas freeing and inerting.
- There shall be one manual shutdown valve in the LFL supply line to each engine to assure safe isolation during maintenance on the engine.

These requirements are functional and therefore up for interpretation from the designer and maker of the fuel system. Several solutions exist, but the main common denominator is that the methanol fuel system needs to be drained, purged and gas freed, throughout the entire system. This is also applicable for the residues in the main engine. Methanol is finally collected, back into the service tank, or to an additional residue tank.

The nitrogen installation plays a central role in the total cycle and the requirements to the nitrogen installation is presented in the following:

- All tanks containing LFL shall be inerted.
- To prevent the return of fuel vapour to any gas safe spaces, the inert gas supply line shall be fitted with two shut-off valves in series with a venting valve in between (double block and bleed valves). In addition a closable non-return valve shall be installed between the double block and bleed arrangement and the fuel tank. These valves shall be located outside non-hazardous spaces and must function under all normal conditions of trim, list and motion of the ship. The following conditions apply:
  - Where the connections to the fuel tanks or to the fuel piping are non-permanent, two non-return valves may substitute the non-return devices required above.
  - Low-pressure alarm shall be provided in the nitrogen supply line on the fuel tank side of any double block and bleed valves and pressure reduction units. If pressure/vacuum alarms are fitted in each fuel tank as means to comply with redundant venting requirements, a separate low-pressure alarm is not required.
  - A high oxygen content alarm shall be provided in the engine control room. The alarm is to be activated when the oxygen content in the inert gas supply exceeds 5%.
  - Where a nitrogen generator or nitrogen storage facilities are installed in a separate compartment, outside of the engine room, the separate compartment shall be fitted with an independent mechanical extraction ventilation system, providing 6 air changes per hour. A low oxygen alarm shall be fitted. Such separate compartments shall be treated as one of other machinery spaces, with respect to fire protection.

#### **Addressed safety aspects:**

To handle methanol after the main engine is especially related to dual fuel engines and in the case of a fuel switchover. It is also important to the above mentioned requirement, in the case of maintenance of the engine. Hence there are a number of scenarios where the fuel piping will have to be emptied for methanol, due to the low flashpoint and the toxicity of the fuel.

According to MAN Diesel & Turbo<sup>/21/</sup> for their engine, fuel piping to the engine and in the engine room is arranged so that the liquid fuel can be purged and thereby returned to the fuel service tank. After the methanol fuel has been returned to the service tank, full purging and inerting are conducted for the double walled piping system. All purging and inerting is distributed, for every subsystem, by the nitrogen installation.

#### **5.2.6 Ship type considerations**

Ship specific requirements according to the DNV GL rules<sup>/19/</sup> are divided into the following ship types: Working ships (e.g. offshore supply vessel), Cargo ships (e.g. chemical tanker) and Passenger vessels (e.g. cruise ship), as shown in Figure 5-6.

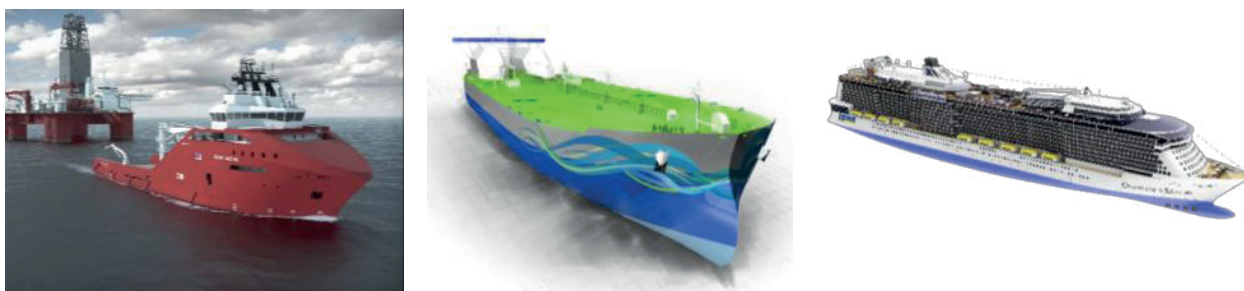

**Figure 5-6:** *Ship types*

**Working ships, e.g. offshore supply vessel:**

For this group, additional requirements apply regarding general aspects.

**General:**

- LFL fuel tanks on deck are not accepted on offshore supply vessels.
- The aft- and forepeak in offshore supply vessels cannot be used as cofferdam space for a LFL fuel tank.

**Cargo ships, e.g. chemical carrier:**

For this group, additional requirements apply regarding arrangement, fire safety and segregation of cargo- and fuel system.

**Arrangement:**

- A dedicated LFL fuel service tank shall be provided. The piping system serving this tank shall be separated from cargo handling piping systems, except for the fuel transfer pipes from tanks for fuel storage.

**Fire safety:**

- Measures shall be implemented to reduce the consequences of fire and explosions in cargo tanks and in the cargo area for the dedicated LFL fuel service tanks and LFL fuel supply systems.
- Inerting of cargo tanks during cargo tank cleaning operations and inert gas purging prior to gas freeing would be considered an acceptable measure to reduce the consequence of in-tank explosion. Such inerting should be performed for all cargo tanks and regardless of size of ship.
- LFL fuel tanks and associated tank connection spaces (if fitted) on weather deck shall be protected by a water spray system for cooling and fire prevention and to cover exposed parts of the tank located on open deck.
- This system comes in addition to the deck foam firefighting system required for chemical tankers.
- For the purpose of isolating damaged sections, manual stop valves shall be fitted or the system may be divided into two sections with control valves located in a safe and readily accessible position not likely to be cut-off in case of fire.
- The system shall be served by a separate water spray pump with capacity sufficient to deliver the required amount of water.
- A connection to the ship's fire main through a stop valve shall be provided.

**Segregation of cargo- and fuel system:**

- Measures shall be provided to prevent inadvertent transfer of incompatible or contaminating cargo to the fuel system, after the fuel storage tanks have been loaded.
- If cargo tanks located within the cargo area are used as LFL fuel storage tanks, these cargo tanks shall be dedicated as LFL fuel tanks when the ship is operating on LFL fuel.
- Any cargo liquid line for dedicated LFL fuel storage tanks shall be separated from liquid cargo piping serving other cargo tanks, including common liquid cargo piping.
- Cross-connections to cargo liquid piping serving common systems or other tanks may be accepted provided the connections are arranged with spool pieces, typically swing bends. The arrangement of spool pieces shall be such that even if a spool piece is unintentionally left in place, inadvertent transfer of incompatible or contaminating cargo from or to the dedicated LFL fuel storage tank is not possible. The piping and manifold serving the dedicated LFL fuel storage tanks shall be specially colour coded.
- The cargo tank venting system for the dedicated LFL fuel tanks shall be separated from venting systems from other cargo tanks when operating on LFL fuel.

- Other cargo handling systems serving other cargo tanks such as tank washing, inert gas and vapour return shall be separated when used as LFL fuel storage tanks. Inert gas systems may be accepted connected to a common system when used as LFL fuel storage tanks, provided the system is under continuous pressure.
- LFL fuel tank location shall take into account compatibility with other cargoes. When carrying LFL fuel in the storage tanks, these tanks cannot be located adjacent to cargo tanks intended for cargoes that are not compatible with the LFL fuel.

**Passenger ships, e.g. cruise ships:**

For this group, additional requirements apply regarding general aspects.

**General:**

- Areas classified as hazardous zone shall be inaccessible for passengers at all times.
- The aft- and forepeak in passenger vessels cannot be used as cofferdam space for a LFL fuel tank.

The main differences between these ship types are found for chemical tankers and are mainly considering additional fire safety and additional requirements to avoid contamination of the fuel from the cargo.

### 5.3 Summary of technology readiness

A summary of the system breakdown is presented in the following tables, describing each subsystem. The tables are describing the level of technology readiness by an evaluation of the equipment and components for each system.

**Table 5-1: Summary of technology readiness for bunkering of methanol**

| System component  | Technology readiness | Remarks   |
|---|----------------------|---|
| Mechanical ventilation                                    | Mature               | Dependent on location of bunkering station                |
| Coamings fitted   | Mature               |   |
| Control from safe location                                | Mature               |   |
| Pipes self-drained, arranged for inerting and gas freeing | Mature               |   |
| System for cargo and fuel segregation                     | Mature               | Dependent on the ship type, relevant for chemical tankers |
| Transfer coupling shall automatically close at disconnect | Mature               |   |
| Monitoring and control systems                            | Mature               |   |
| Drip trays  | Mature               | Below all possible leakage points                         |

**Table 5-2: Summary of technology readiness for storage of methanol**

| System component   | Technology readiness                         | Remarks   |
|--|--|---|
| Inlet and outlet piping  | Mature                                       |   |
| Level indicators   | Mature                                       |   |
| Arrangement for inerting and gas freeing, by nitrogen installation | Mature                                       |   |
| Remotely operated shut-off valves and control system               | Mature                                       |   |
| Filtering of methanol  | Mature                                       | Especially for chemical tankers with methanol fuel service tank |
| Drip trays   | Mature                                       | Below all possible leakage points                               |
| Fire detection – IR CCTV   | Relatively new, but used in other industries | This is due to methanol fire being invisible                    |
| Fixed foam fire extinguishing system                               | Mature                                       | For fuel tanks on weather deck                                  |



**Table 5-3:** Summary of technology readiness for methanol handling and processing before the main engine

| System component  | Technology readiness | Remarks  |
|---|----------------------|--|
| Double walled piping and corresponding ventilation of annular space | Mature               | Used for LNG as fuel systems                   |
| Liquid and vapour detection   | Mature               |  |
| Remotely operated valves  | Mature               |  |
| Filtering system  | Mature               |  |
| Supply pump   | Mature               |  |
| Circulation circuit   | Mature               | Keep supply higher than the fuel consumption   |
| Double block and bleed valve configuration                          | Mature               |  |
| Arrangement for inerting and gas freeing, by nitrogen installation  | Mature               | For drainage and purging of the methanol lines |
| Temperature and pressure control system                             | Mature               |  |
| Temperature regulation system                                       | Mature               |  |
| Ventilation system of rooms containing equipment                    | Mature               |  |
| Drip trays  | Mature               | Below all possible leakage points              |

**Table 5-4:** Summary of technology readiness for combustion of methanol in the main engine

| System component   | Technology readiness  | Remarks   |
|--|---|---|
| Double walled fuel pressure lines                              | Mature  | All methanol fuel lines to the main engine          |
| Additional LFL engine monitoring systems                       | Relatively new application <sup>/21/</sup>                            | Detect LFL ignition controlling automatic shutdown  |
| Additional sealings  | Mature  | Avoid leakage to the engine room                    |
| Additional methanol fuel injection system                      | Relatively new application, built on a mature concept <sup>/21/</sup> | Relevant for dual fuel system                       |
| Combined sealing and cooling oil system to the injection valve | Relatively new application <sup>/21/</sup>                            | Due to the non-lubricant effects of methanol        |
| Liquid and vapour detection                                    | Mature  |   |
| Purge return system  | Relatively new application <sup>/21/</sup>                            | Purging and inerting of methanol in the main engine |
| Fire detection to engine room – IR CCTV                        | Relatively new, but used in other industries.                         | This is due to methanol fire being invisible        |

**Table 5-5:** Summary of technology readiness for methanol handling and processing after the main engine

| System component  | Technology readiness | Remarks   |
|---|----------------------|---|
| Double block and bleed valve configuration for the nitrogen injection | Mature               | Configuration needed to avoid methanol vapour back to the nitrogen system |
| Remotely operated shut-off valves and control system                  | Mature               |   |
| Manual valves   | Mature               |   |
| Liquid and vapour detection   |                      |   |
| Double walled piping  | Mature               |   |

Table 5-1 to Table 5-5 show that the methanol fuel system is built mainly of well-known components, and that the individual components are of a mature technology and have been used in the maritime industry. The main new aspect is in fact the connection of all these components along the methanol flow and how they are interacting with each other. The interaction between the components is important in a safety aspect, especially regarding the methanol fuel system shutdown. In a situation when methanol fuel shutdown is needed, the pipes are purged and emptied. This is an interaction process, opening and closing the valves along the methanol flow in the correct sequence.

Challenges, such as material selection to avoid leakages, have been identified by the industry. This is due to the low viscosity of methanol and the effect this property has on commonly used materials. Experience gained after running on methanol has been used in developing more reliable solutions, especially related to material selection in components subjected to leakages. This effect will continue in the industry when several shipowners choose methanol as fuel.

## 5.4 Costs of methanol as fuel

The costs of methanol as fuel are estimated from two perspectives: that of the shipowner, and that of the methanol producer. First, the methanol price necessary to generate a favourable payback period for the capital investment of methanol propulsion is calculated. The necessary price of methanol from the shipowner's point of view is then compared to estimations of the cost of methanol production.

### 5.4.1 Methanol price from the shipowner's perspective – Payback time for methanol propulsion

The payback time for running a ship on methanol in ECAs will be dependent on the additional capital costs of methanol propulsion and the potential savings/extra costs in case methanol is cheaper or more expensive than the alternatives. In an ECA, the typical fuel for comparison will be MGO; however, the shipowner can also consider using HFO with an exhaust gas cleaning system (scrubber). Scrubbers have a certain capital and operational cost but allow the shipowner to run on relatively cheap HFO in ECAs. An estimate of the payback time for a ship employing a scrubber is therefore also calculated for perspective.

LNG can also be an alternative. LNG has high capital costs, but may be a cheaper fuel than MGO and somewhat cheaper than HFO. However, in this study, the costs of the LNG-alternative are not modelled.

The summary presented in section 5.3 shows the additional components and safety systems which constitute the methanol fuel system. The additional capital cost necessary for methanol propulsion is based on the cost of the items presented in section 5.3, and determined for two cases:

- Newbuild vessel
- Retrofit of existing vessel

The capital costs calculated are relevant for a ro-ro vessel with 24 000 kW installed main engine power and tank capacity for 3 days sailing. There are, as discussed above, some differences among the different ship types, but this assessment is a coarse estimate used to show how the additional capital costs interact with the price of fuel to determine the payback for a ship running on methanol. The costs for the necessary additional components presented in this chapter are based on discussion with the industry and represent current systems. The additional capital costs for a newbuild with a methanol fuel system are presented in Table 5-6, while the retrofit case is presented in Table 5-7.

**Table 5-6:** *Approximate additional costs for a newbuild with the total methanol fuel system*

| System component                  | Cost (Million USD) |
|-----------------------------------|--------------------|
| Engine and equipment costs        | 5.5                |
| Storage of methanol               | 0.1                |
| <b>Total costs for a newbuild</b> | <b>5.6</b>         |

The additional capital costs for retrofit of the methanol fuel system presented in Table 5-7.

**Table 5-7:** *Approximate additional costs for retrofit with the methanol fuel system*

| System component                | Cost (Million USD) |
|---------------------------------|--------------------|
| Engine costs                    | 3.5                |
| Other equipment                 | 3.5                |
| Additional shipyard costs       | 3.5                |
| <b>Total costs for retrofit</b> | <b>10.5</b>        |

In the following the costs in Tables 5-6 and 5-7 are used as input to the calculation of payback time of a methanol fuel. For comparison, a SO<sub>x</sub> scrubber for a similar total installed power is assumed to cost 6 MUSD for a retrofit, with this cost being reduced by 50% for a newbuild. These estimates are based on DNV GL experience and quotes from scrubber manufacturers.

The additional costs of methanol propulsion for a newbuild are approximately half the size of those for a retrofit case, mainly due to the fact that the tank of a newbuild is incorporated into the design of the vessel from the start, and its placement in the vessel will not constitute an additional cost to the shipowner. For a retrofit, we have assumed a separate tank not integrated into the existing vessel and this will constitute an additional cost. Besides the tank cost, a newbuild is less expensive to run on methanol because it is easier to use a dual fuel engine than to custom retrofit an engine.

These additional capital costs were used as input to calculate the payback time of a methanol fuel system compared to fuel switch (using MGO) or installing a scrubber (using HFO) to cope with the regulations and environmental requirements in ECAs.

The calculations for payback time are based on an assumption of the time spent in ECA as a portion of the whole sailing time and the corresponding fuel consumption. The more fuel the ship consumes in ECA the bigger the opportunity to save money by buying cheaper fuel. The payback time is calculated as the time it takes for the potential fuel cost savings to recuperate the initial capital costs, based on varying rates of ECA exposure and various price differences of methanol compared to MGO. Fuel costs are calculated for 15 years after the initial capital investment and a discount rate of 8% is employed.

Two MGO price scenarios are used to estimate the payback time for a methanol fuel system versus fuel switch to MGO. The high price scenario assumes a price close to those of mid-2014 Rotterdam MGO prices (865 USD/tonne). The low price scenario assumes an MGO price close to those of mid-2015 Rotterdam MGO prices (450 USD/tonne). A calculation of the payback time of choosing HFO with a scrubber versus fuel switch to MGO is also performed as comparison.

In order to determine if the methanol prices necessary to achieve a certain payback period are reasonable, we compare the necessary methanol price to historic methanol prices. Historical prices are shown in Figure 5-7.

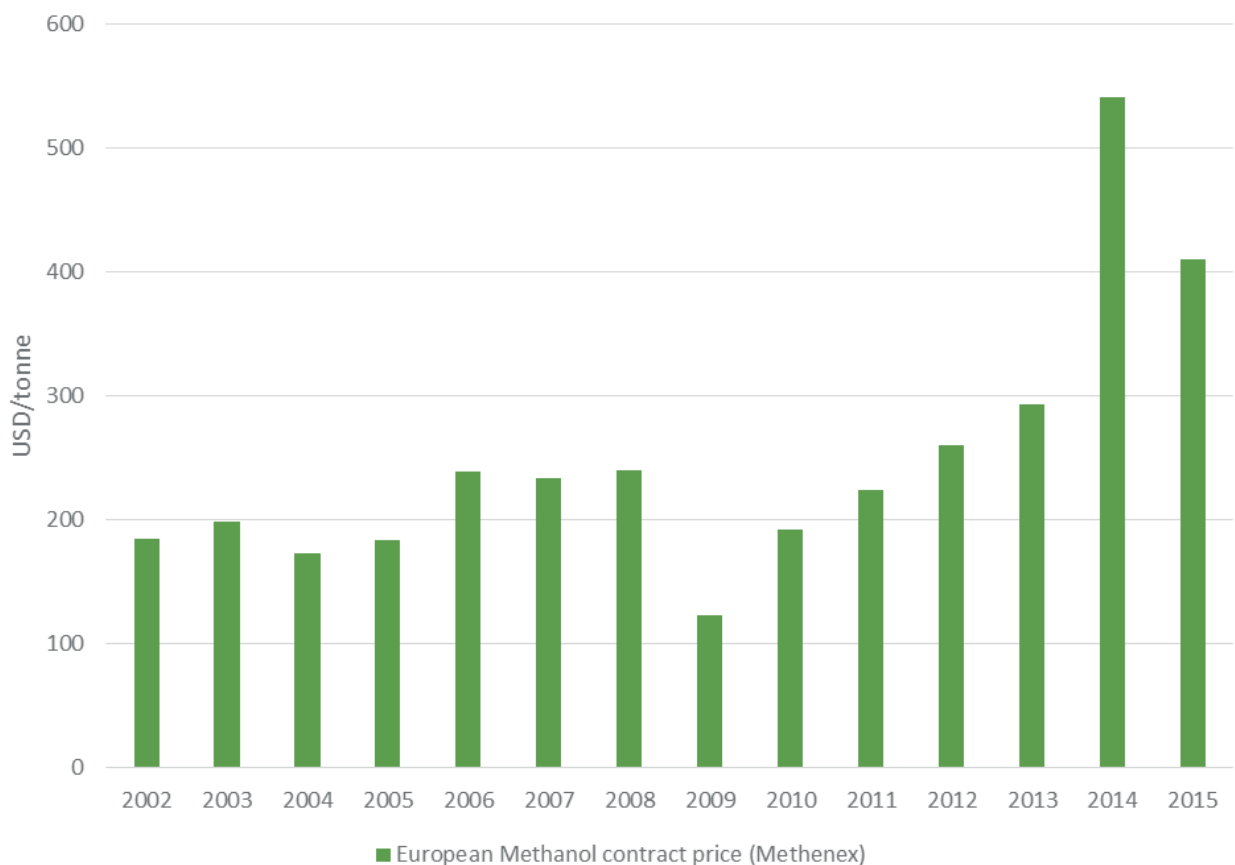

Figure 5-7: Historical methanol prices in Europe



The payback time of methanol compared to MGO is presented as a function of methanol price as percentage of MGO per energy unit. The payback time is presented with a colour coding to reflect how attractive the payback period is for a shipowner, shown in Table 5-8.

**Table 5-8:** Colour coding describing payback time intervals

| Colour Code | Description   |
|-------------|---|
|             | The payback time of methanol compared to fuel switch is greater than 15 years |
|             | The payback time of methanol compared to fuel switch is 10-15 years           |
|             | The payback time of methanol compared to fuel switch is 7-10 years            |
|             | The payback time of methanol compared to fuel switch is 3-7 years             |
|             | The payback time of methanol compared to fuel switch is less than 3 years     |

The case presented in Table 5-9 represents the payback period of a newbuild vessel running on methanol with the low MGO price scenario. This MGO price represents the current MGO market price. The results show that with a low MGO price scenario, the payback time of methanol is relatively high. For example, if the ship spends 100% of time in ECA, and the price of methanol is 75% of MGO (on energy basis), the payback time is 6.8 years. For most shipowners, this is a relatively long payback time considering that the price of fuel, and thus the payback period, is so unpredictable.

Looking at Table 5-9, the competitive methanol price needed to achieve a payback time lower than that of a scrubber is in this case unrealistically low at 85 USD per tonne. Figure 5-7 shows that such a low price for methanol has not been witnessed historically. This shows that methanol is not an attractive option from a price perspective for a newbuild vessel and today's MGO prices (i.e. the low price scenario).

**Table 5-9:** Sensitivity price newbuild with a low MGO price scenario

| Tonnes HFO equivalents consumed in ECA |   | 1000                                       | 3000 | 4900 | 7400 | 9900 |
|--|---|--|------|------|------|------|
| Time spent in ECA                      |   | 10%  | 30%  | 50%  | 75%  | 100% |
| Methanol price USD/tonne               | Methanol price as percentage of MGO (per unit energy) | <b>Payback of scrubber compared to MGO</b> |      |      |      |      |
|  |   | 7.4  | 5.9  | 4.7  | 3.4  | 2.4  |
|  |   | <b>Payback of methanol compared to MGO</b> |      |      |      |      |
| 85                                     | 40  | 5.1  | 4.4  | 3.7  | 3.0  | 2.5  |
| 95                                     | 45  | 5.7  | 4.9  | 4.2  | 3.3  | 2.7  |
| 106                                    | 50  | 6.5  | 5.6  | 4.7  | 3.8  | 3.0  |
| 116                                    | 55  | 7.6  | 6.4  | 5.4  | 4.3  | 3.4  |
| 127                                    | 60  | 9.2  | 7.6  | 6.4  | 5.0  | 3.9  |
| 138                                    | 65  | 11.1                                       | 9.1  | 7.5  | 5.9  | 4.5  |
| 148                                    | 70  | 13.4                                       | 10.8 | 8.9  | 6.9  | 5.4  |
| 159                                    | 75  |  | 13.8 | 11.1 | 8.6  | 6.8  |

The case presented in Table 5-10 represents the payback period of a newbuild running on methanol with the high MGO price scenario. This MGO price represents the MGO market price from mid-2014, before the drop in oil price. The results show that with a high MGO price scenario, the payback time of methanol is relatively low. The competitive methanol price needed to achieve a payback time lower than that of installing a scrubber is realistic in this case, at 204 USD per tonne. This shows that methanol is an attractive option from a price perspective.

**Table 5-10: Sensitivity price newbuild with a high MGO price scenario**

| Tonnes MGO equivalents consumed in ECA |   | 1000                                | 3000 | 4900 | 7400 | 9900 |
|--|---|-------------------------------------|------|------|------|------|
| Time spent in ECA                      |   | 10%                                 | 30%  | 50%  | 75%  | 100% |
| Methanol price USD/tonne               | Methanol price as percentage of MGO (per unit energy) | Payback of scrubber compared to MGO |      |      |      |      |
|  |   |                                     | 5.9  | 4.6  | 3.2  | 2.1  |
|  |   | Payback of methanol compared to MGO |      |      |      |      |
| 163                                    | 40  | 2.3                                 | 1.9  | 1.7  | 1.4  | 1.2  |
| 183                                    | 45  | 2.8                                 | 2.3  | 1.9  | 1.6  | 1.4  |
| 204                                    | 50  | 3.5                                 | 2.7  | 2.2  | 1.8  | 1.5  |
| 224                                    | 55  | 4.3                                 | 3.3  | 2.6  | 2.0  | 1.7  |
| 244                                    | 60  | 5.0                                 | 4.2  | 3.2  | 2.4  | 1.9  |
| 265                                    | 65  | 6.0                                 | 4.9  | 4.0  | 2.8  | 2.2  |
| 285                                    | 70  | 7.6                                 | 6.1  | 4.9  | 3.6  | 2.6  |
| 305                                    | 75  | 8.8                                 | 7.1  | 5.7  | 4.3  | 3.2  |

The case presented in Table 5-11 represents the payback period of a vessel retrofitted to run on methanol with a low MGO price scenario. The results show that with a low MGO price scenario the payback time of methanol is high. The competitive methanol price needed to achieve a payback time lower than that of installing scrubber is in this case unrealistically low at 85 USD per tonne. This therefore shows that methanol no longer is an attractive option from a price perspective.

**Table 5-11: Sensitivity price retrofit with a low MGO price scenario**

| Tonnes MGO equivalents consumed in ECA |   | 1000                                | 3000 | 4900 | 7400 | 9900 |
|--|---|-------------------------------------|------|------|------|------|
| Time spent in ECA                      |   | 10%                                 | 30%  | 50%  | 75%  | 100% |
| Methanol price USD/tonne               | Methanol price as percentage of MGO (per unit energy) | Payback of scrubber compared to MGO |      |      |      |      |
|  |   |                                     | 12.8 | 10.5 | 8.7  | 6.8  |
|  |   | Payback of methanol compared to MGO |      |      |      |      |
| 85                                     | 40  | 8.9                                 | 7.9  | 7.1  | 6.1  | 5.3  |
| 95                                     | 45  | 10.2                                | 9.0  | 8.0  | 6.8  | 5.9  |
| 106                                    | 50  | 12.0                                | 10.5 | 9.2  | 7.8  | 6.6  |
| 116                                    | 55  | 14.6                                | 12.5 | 10.8 | 9.0  | 7.5  |
| 127                                    | 60  |                                     |      | 13.1 | 10.7 | 8.8  |
| 138                                    | 65  |                                     |      |      | 13.2 | 10.6 |
| 148                                    | 70  |                                     |      |      |      | 13.5 |
| 159                                    | 75  |                                     |      |      |      |      |

The case presented in Table 5-12 represents the payback period of a vessel retrofitted to run on methanol with a high MGO price scenario. The results show that with a high MGO price scenario, the payback time of methanol is relatively low. The competitive methanol price needed to achieve a payback time lower than installing scrubber is in this case realistic at 204 USD per tonne. This shows that methanol is an attractive option from an economic perspective.

**Table 5-12: Sensitivity price retrofit with a high MGO price scenario**

| Tonnes MGO equivalents consumed in ECA |   | 1000                                | 3000 | 4900 | 7400 | 9900 |
|--|---|-------------------------------------|------|------|------|------|
| Time spent in ECA                      |   | 10%                                 | 30%  | 50%  | 75%  | 100% |
| Methanol price (USD/tonne)             | Methanol price as percentage of MGO (per unit energy) | Payback of scrubber compared to MGO |      |      |      |      |
|  |   | 8.7                                 | 7.1  | 5.7  | 4.3  | 3.2  |
|  |   | Payback of methanol compared to MGO |      |      |      |      |
| 163                                    | 40  | 4.6                                 | 4.0  | 3.4  | 2.9  | 2.5  |
| 183                                    | 45  | 5.1                                 | 4.5  | 3.9  | 3.2  | 2.8  |
| 204                                    | 50  | 5.8                                 | 5.1  | 4.4  | 3.7  | 3.1  |
| 224                                    | 55  | 6.7                                 | 5.8  | 5.1  | 4.2  | 3.5  |
| 244                                    | 60  | 8.0                                 | 6.9  | 5.9  | 4.9  | 3.9  |
| 265                                    | 65  | 9.8                                 | 8.3  | 7.1  | 5.7  | 4.6  |
| 285                                    | 70  | 12.9                                | 10.7 | 8.8  | 7.0  | 5.5  |
| 305                                    | 75  |                                     | 13.4 | 11.0 | 8.7  | 6.9  |

In the cases with a low MGO price according to the current market, the methanol price necessary to achieve a payback time lower than that of installing a scrubber is 85 USD per tonne in the case of both a newbuild and a retrofit. This price is too low compared to the historical prices of methanol to be considered reasonable. Methanol as fuel is therefore not an economically attractive option in given low MGO prices. Given the high MGO price scenario, the methanol prices necessary to achieve a payback time lower than that of installing a scrubber is 204 USD per tonne for a newbuild or retrofit. This methanol price has occurred before and can be reasonably expected, making methanol a more financially attractive option. The result is also dependent on the time spent in ECA, and if this time is approaching 100%, methanol as fuel shows great potential in all cases except in the case of a retrofit in combination with a low MGO price.

#### 5.4.2 Methanol price based on methanol production

The four cases presented in section 5.4.1 above show the methanol prices compared to MGO which would be necessary for methanol to be an economically viable alternative way of satisfying the ECA requirements. This is the price seen from a shipowner's perspective based on the additional capital costs of the methanol fuel system and the costs of other marine fuel alternatives, but it is important to understand how the methanol prices calculated in section 5.4.1 relate to the actual price of methanol that can be expected in the market.

Figure 5-8 shows a comparison of the historical European natural gas price and historical European methanol price. (The historical prices are the same as shown in Figure 5-7.) Understanding the relationship between the two prices is important since natural gas is the feedstock used in most of the world's production of methanol. A minimum methanol selling price is derived from this comparison.

The blue line in the figure shows methanol as percentage of natural gas price per energy basis. Figure 5-8 shows that the price of methanol has not followed the price of natural gas historically. This may be due to the fact that natural gas used to produce methanol is sometimes stranded natural gas, a by-product of oil production which would otherwise be flared in the field. The price of the feedstock is therefore not directly related to the regular consumer price of natural gas. Additionally, methanol is a commodity which is often shipped. The methanol sold in Europe can be based on natural gas coming from different parts of the world. These kinds of market mechanisms are difficult to quantify.

However, if methanol becomes a widespread shipping fuel, the higher demand for methanol could link its price more closely to the natural gas price because natural gas used to create methanol will no longer be stranded natural gas which would otherwise be flared. It will be produced from pipeline gas. This means that the price of methanol will be more dependent on the nominal price of natural gas. Therefore, given a maximum energy efficiency 70% for the natural gas feedstock when methanol is created from natural gas and a natural gas price from 2015 (355 USD/tonne) the minimum methanol selling price is about 216 USD/tonne.

This methanol selling price compared to the prices derived in section 5.4.1 shows that methanol as fuel is not an alternative in the case of the low MGO price scenario. In the scenario with high MGO price, however, 216 USD/tonne methanol could be attractive given that the vessel in question spends significant time in ECA.

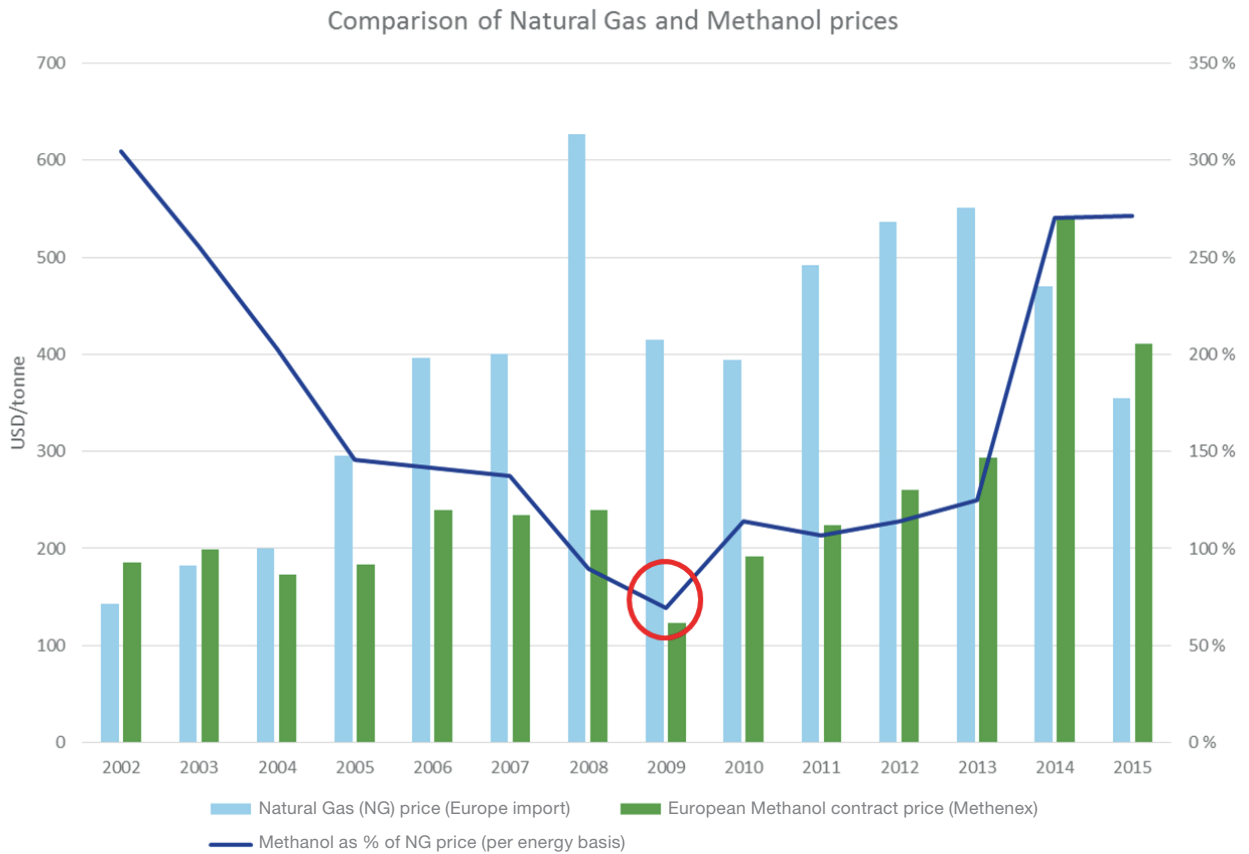

Figure 5-8: Comparison of natural gas and methanol prices

### 5.5 Encouraging the use of methanol

Of the three emissions types considered in this study and their relevant regulatory regimes, sulphur is the only emissions type for which methanol is a clear alternative in order to satisfy regulations.

Table 5-13: Methanol’s relevance to emissions and their corresponding regulations

| Emissions type                       | CO <sub>2</sub>  | SO <sub>x</sub>  | NO <sub>x</sub>   |
|--------------------------------------|--|--|---|
| Relevant regulatory regime           | EEDI   | SECAs  | NECAs (NO <sub>x</sub> Tier III)  |
| Methanol’s relevance to requirements | Current experience indicates that methanol increases energy efficiency with a few percentage points. This would have to be documented further in order to be applicable in EEDI. EEDI does not consider biofuels specifically, so the CO <sub>2</sub> emissions factor for ships running on methanol must be determined by the flag State. | Methanol propulsion satisfies SECA requirements of maximum 0.1% sulphur in fuels | Measurements indicate that methanol may reduce NO <sub>x</sub> emissions significantly, but not down to Tier III levels. Further tests may show that methanol can be combined with other NO <sub>x</sub> abatement technologies, such as exhaust gas recirculation (EGR), in order to bring emissions down to Tier III. |

The current incentives for shipowners to choose methanol are the SECA requirements which imply the use of low sulphur fuels or scrubbers. The capex and the uncertainty of fuel savings are the current most important barriers for a shipowner choosing methanol over another low-sulphur solution. The assessment of economic feasibility shows that a scrubber has a similar payback time, but less uncertainty. This is because it is more certain that a shipowner can save money running on HFO than running on methanol, given the fluctuations of MGO and methanol price.

The SECAs provide incentive for a shipowner to choose a low-sulphur fuel, of which methanol is just one possibility, and not necessarily the most economically viable. In order to encourage the uptake of methanol, subsidies could be granted which would ease the burden of the capital costs, and make the business case for methanol less certain.

In Norway, the NO<sub>x</sub> fund provides an example of one scheme which has been used to encourage the use of low NO<sub>x</sub> technologies such as selective catalytic reduction (SCR) and LNG. The Business Sector's NO<sub>x</sub> Fund was initiated after the introduction of the Norwegian tax on NO<sub>x</sub> emissions in 2007. The fund is based on an industry/authority agreement for a period of ten years, including tax relief and quantitative NO<sub>x</sub> reduction commitments. Instead of paying a state tax (of significant size), enterprises who are part of the NO<sub>x</sub> fund pay a much lower (approximately 1/5 of the state tax) into the Fund. The enterprises must implement NO<sub>x</sub> reducing measures to an extent that the reduction commitments are met. For this, they can then apply for financial support for the installation of NO<sub>x</sub> reducing technologies (going beyond existing regulations), receiving up to 80% coverage of their investment. Shipowners must document that the technology in question, potentially methanol, has a documented NO<sub>x</sub> reducing effect, and the support is dimensioned according to actual achieved and documented emission reduction during operation. The Norwegian NO<sub>x</sub> fund has provided such subsidies for LNG, SCR, low-NO<sub>x</sub> engine solutions, engine replacements, battery/hybrid ships, EGR and various fuel-saving technologies with success. This has catalysed the market for instance for LNG propulsion in Norway.

Although the Norwegian NO<sub>x</sub> fund is not necessarily an applicable model in many places, there are several conclusions which can be derived from its effectiveness. The success of the NO<sub>x</sub> fund is dependent on the NO<sub>x</sub> tax. Money collected by the NO<sub>x</sub> fund as the reduced NO<sub>x</sub> tax that its members pay to the fund goes entirely and directly to reduce NO<sub>x</sub>. The fund is believed to be more effective than a "passive" NO<sub>x</sub> tax, which is a burden on industry but does not necessarily provide industry with the means of reducing their emissions.

Experience from the NO<sub>x</sub> fund shows that shipowners need both the carrot and the stick in order to stimulate uptake of alternative fuels. A mechanism which allows the financial burden (tax) of emissions to commit directly to industry's ability to reduce the emission allows for the uptake of new technologies.

Methanol could be encouraged through a scheme to reduce carbon emissions. The advantage of encouraging methanol through a carbon tax, or a scheme to reduce carbon emissions, is that bio-methanol is a measure which reduces CO<sub>2</sub> emissions significantly, whereas LNG only to a certain extent can reduce CO<sub>2</sub> emissions, and scrubbers do not have an CO<sub>2</sub> reduction effect at all. In addition, methanol reduces SO<sub>x</sub> and particles such as LNG, and likely also NO<sub>x</sub> (although not as efficient as many of the LNG solutions).

Methanol produced with natural gas does not reduce CO<sub>2</sub> emissions from a lifecycle perspective, but it could be considered a CO<sub>2</sub> measure in that methanol as fuel has the potential to be created from biomass, as opposed to conventional fuels and LNG, which are fossil-based by definition.

# 6

## Conclusions

The environmental assessment of methanol used as ship fuel shows that, for a lifecycle perspective, methanol produced with natural gas has higher GHG emissions than conventional fuels. However, methanol produced from biomass has the potential to reduce emissions significantly, provided that the electricity used in the process is relatively clean. The lifecycle  $\text{NO}_x$  emissions from methanol are approximately 45% of those of conventional fuels per unit energy and the lifecycle  $\text{SO}_x$  emissions of methanol are approximately 8% of those of conventional fuels per unit energy. In the case of both  $\text{NO}_x$  and  $\text{SO}_x$ , the emissions reductions are due to the fact that methanol results in lower emissions during the combustion phase.

The International Code of Safety for Ships using Gases or other Low-flashpoint Fuels provides an international standard for ships using low-flashpoint fuel, which provides mandatory provisions for the systems using low-flashpoint fuel to minimize the risk to the ship, its crew and the environment.

The assessment of technology readiness of methanol as fuel shows that the methanol fuel system consists mostly of well-known components, and that the individual components are of a mature technology and have been used in the maritime industry. The new application is the connection of all these components along the methanol flow and their interaction. The assessment also shows that additional safety barriers are needed in every part of the methanol fuel system. From a technical aspect this is very much achievable for shipowners, both for newbuild and retrofit systems.

From a cost perspective, methanol as fuel shows potential only within certain circumstances. These are mainly that MGO prices are high and that the time spent in ECAs is a large portion of the total sailing time.





# 7

## References

- /1/ Southern Chemical Corporation , What is methanol, how is it used?  
<http://www.southernchemical.com/wp/products/methanol/principle-uses>
- /2/ TIAX for Methanol Institute, White paper: Methanol as a renewable energy resource, January 2013,  
[http://www.methanol.org/getdoc/300af053-04bd-4b2a-8dce-f6a3e4c4d4ce/MI-Renewable-Methanol-Pathways-White-Paper\\_final.aspx](http://www.methanol.org/getdoc/300af053-04bd-4b2a-8dce-f6a3e4c4d4ce/MI-Renewable-Methanol-Pathways-White-Paper_final.aspx)
- /3/ 2014 Guidelines on the method of calculation of the attained Energy Efficiency Design Index (EEDI) for new ships (resolution MEPC.245(66))
- /4/ IMO, MARPOL Annex VI, Chapter 1, Regulation 4. Annex to Protocol of 1997 to amend the International Convention for the Prevention of Pollution from Ships, 1973, as modified by the Protocol of 1978 relating thereto
- /5/ Veritas Petroleum services, Circular: China implements Emissions Control Areas, 9 December 2015
- /6/ Foster, P. et al. "Changes in Atmospheric Constituents and in Radiative Forcing", Chapter 2, IPCC, 2007.  
<http://www.ipcc.ch/pdf/assessment-report/ar4/wg1/ar4-wg1-chapter2.pdf>
- /7/ Olah, G.A., Geoppert, A., Surya Prakash, G.K. (2009) "Beyond oil and gas: The methanol economy" 2nd Ed., Wiley-VCH 2009
- /8/ Methanol Institute, How is methanol made?  
<http://www.methanol.org/methanol-basics/overview/how-is-methanol-made-.aspx>
- /9/ Bengtsson, S., Andersson, K., & Fridell, E. (2011). Lifecycle assessment of marine fuels: A comparative study of four fossil fuels for marine propulsion. Gothenburg: Chalmers University of Technology.
- /10/ U.S. Department of Energy, National Energy Laboratory, Lifecycle Greenhouse Gas Perspective on Exporting Liquefied Natural Gas from the United States, 2014
- /11/ Strømman, A. H., Solli, C., & Hertwich, E. (2006). Hybrid life-cycle assessment of natural gas based fuel chains for transportation. Environmental Science and Technology, 2797-2084.
- /12/ Brynolf, S., Fridell, E., & Andersson, K. (2014). Environmental assessment of marine fuels: liquefied natural gas, liquefied biogas, methanol and bio-methanol. Journal of cleaner production, 86-95.
- /13/ Chryssakis, C., Brinks, H., & King, T. (2015). The fuel trilemma: Next generation of marine fuels, Strategic position paper 03-2015. DNV GL Strategic research & innovation.
- /14/ Wärttilä, Methanol as marine fuel, 2015 CIMAC Norway, 28 January 2015, Oslo, Presented by: Lennart Haraldson, Fuel Flexibility, SP 4-stroke/R&D
- /15/ MAN Diesel and Turbo (Groene, Ole), Application of Methanol as Fuel for Ships, 30 June 2015
- /16/ ELCD-CORE-DATABASE-VERSION-II 2009a. Heavy fuel oil. 18th of February 2009 ed.: European Commission - Joint Research Centre - LCA Tools, Services and Data
- /17/ ELCD-CORE-DATABASE-VERSION-II 2009b. Light fuel oil. 18th of February 2009 ed.: European Commission - Joint Research Centre - LCA Tools, Services and Data
- /18/ IMO MSC 95/3/4, 2014-12-5. Development of International Code of Safety for Ships using Gases or other Low-flashpoints Fuels (IGF Code)



- /19/ DNV GL rules for classification of ships. Part 6, Chapter 2, Section 6. Low flashpoint fuelled engines – LFL fuelled
- /20/ MAN Diesel & Turbo, Kjeld Aabo, February 2015. Future fuels for engines
- /21/ MAN Diesel & Turbo. Using Methanol Fuel in the MAN B&W ME-LGI Series
- /22/ Wärtsilä, Methanol – as engine fuel, status Stena Germanica and market overview, Presented by: Toni Stojcevski
- /23/ DNV, January 2012. Gas Fuelled Ship Installations
- /24/ International Maritime Organization, Air pollution and energy efficiency, MEPC 67/INF.15, 18 July, 2014



IMO is the specialized agency of the United Nations with responsibility for ensuring that lives at sea are not put at risk and that the environment is not polluted by international shipping. The Convention establishing IMO was adopted in 1948 and IMO first met in 1959. IMO's 171 member States use IMO to develop and maintain a comprehensive regulatory framework for shipping. IMO has adopted more than 50 binding treaty instruments, covering safety, environmental concerns, legal matters, technical co-operation, maritime security and the efficiency of shipping. IMO's main Conventions are applicable to almost 100% of all merchant ships engaged in international trade.

This study was carried out and published using funds provided to IMO by Transport Canada for analytical studies and other activities pertaining to the control of air related emissions from ships.